

Annual Report

2017/2018

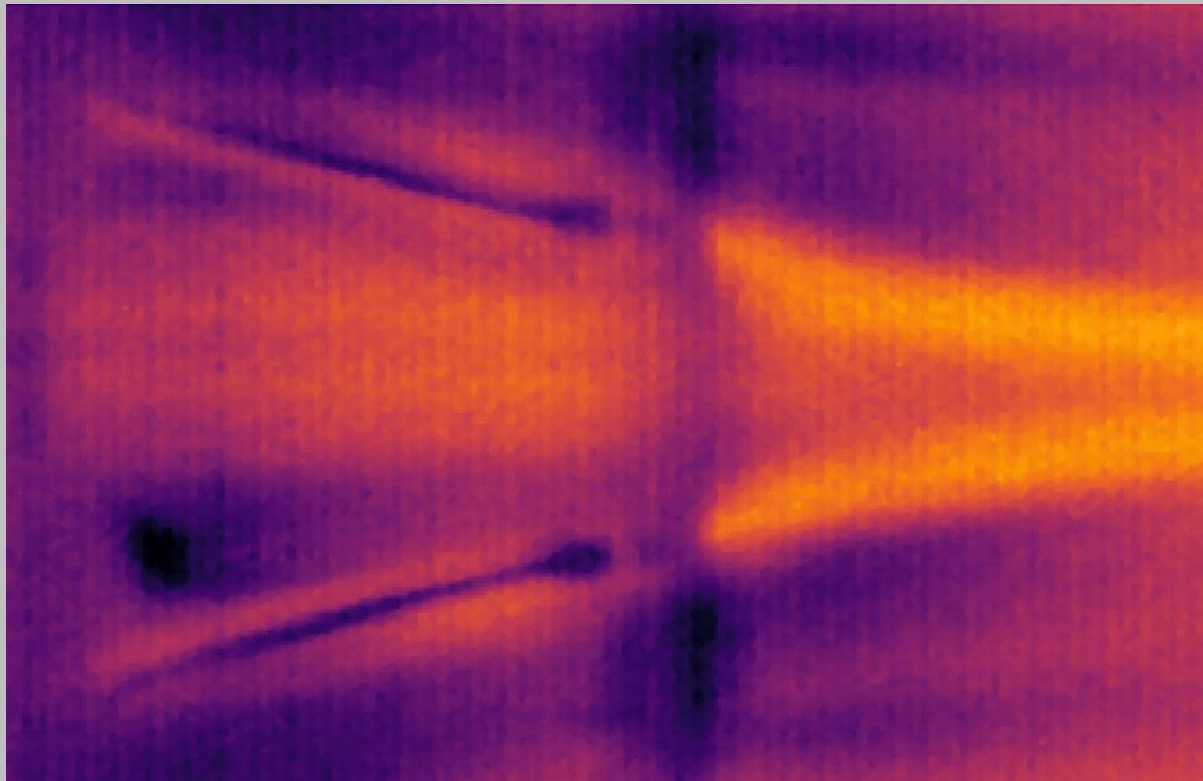

Thermographic visualization of the impact of a vortex generator on the boundary layer flow

BIMAQ

Bremer Institut für
Messtechnik, Automatisierung
und Qualitätswissenschaft



Content

Preface	1
BIMAQ - The Institute	2
▪ Vision, topics and infrastructure	2
▪ Staff	4
▪ Participation in scientific committees and associations	5
▪ Laboratories	6
<i>Laboratory for dimensional metrology</i>	6
<i>Laboratory for large gears</i>	7
<i>Laboratory for optical metrology</i>	8
<i>Laboratory for flow metrology</i>	9
<i>Laboratory for thermography</i>	10
<i>Laboratory for inside-sensing</i>	12
<i>BIMAQ-Technikum and Mechanical workshop</i>	13
Research	14
▪ SFB 747 Micro Cold Forming, Subproject A5 - Controlled scalable laser removal procedure for the manufacturing of contoured micro forming tools	14
▪ SFB 747 Micro Cold Forming, Subproject B5 - Quality inspection and logistic quality control for micro production processes	15
▪ SFB 747 Micro Cold Forming, Subproject B9 - In-situ geometry measurement using confocal fluorescence microscopy	16
▪ SFB/TRR 136 Process Signatures, Subproject C04 - In-situ measurement of mechanical and thermal material loads	17
▪ SFB/TRR 136 Process Signatures, Subproject C06 - Surface-based optical measurements of mechanical material stresses	18
▪ SFB 1232 Coloured states, Subproject D04 - Characterization of colored states by measuring the deformation history during forming	19
▪ MethodMess - Method development for measuring procedures for the in-process-characterization of sub-100-nm-structures	20
▪ MultiSenseo - Multisensory measurement of the geometry of large gears	21
▪ MoQua - Model-based quality control for zero-defect production in a thermo-forming process	22

Content

▪ SelTon - Selftonometer for the determination of intraocular pressure with acoustic vibration excitation - evaluation algorithms and system integration.....	23
▪ OptOChar - Optical in-process surface characterization with hardware acceleration	24
▪ GEOWISOL - Effects of the geographical distribution and temporal correlation of wind and solar input on the power supply system	25
▪ BiSWind - Component integrated sensor system for wind energy systems	26
▪ InSensa - In-process sensors and adaptive control systems for additive manufacturing	27
▪ ThermoFlight - Concept for the development of an optimized maintenance and inspection method for offshore wind turbines using thermography and SHM as non-destructive testing technologies in combination with unmanned aerial vehicles	28
Cooperations with industry and measurement services	29
▪ Cooperation partners	29
▪ Measurement services	31
<i>Dimensional measurements</i>	31
<i>Thermographic flow visualization</i>	31
Teaching activities, student projects, graduation works	32
▪ Teaching activities	32
▪ Student projects	33
▪ Graduation works	33
▪ Awards	34
Publications and qualification of young academics	35
▪ Publications	35
<i>Books</i>	35
<i>Journals</i>	35
<i>Conference contributions with proceedings</i>	37
<i>Conference contributions without proceedings</i>	39
▪ PhD theses	40
Events	41
▪ Participation at events and conferences	41
▪ Events in Bremen	42

Preface

*Dear friends and partners
of the institute!*

The majority of our research activities is focused on optical measurement systems, which still provide fascinating possibilities for measurements at the limits of measurability. In 2017 and 2018 the Bremen Institute for Metrology, Automation and Quality Science (BIMAQ) continues to strengthen the collaborative research activities at the University of Bremen:

- The challenge of allowing optical micro-geometry measurements in-situ during laser chemical machining is met to support the SFB747.
- With the successful application for the second phase of the SFB/TRR136, in-process strain and deformation measurements with nm-precision are developed further to gain new insights in the so-called process signatures of manufacturing processes.
- In the SFB1232, a new project proposal was granted to realize strain measurements of metal micro samples near ultimate resolution and technological limits with a high throughput.

In addition to measurements at solid objects, flow measurements in fluids are now established. A new lab with a stereoscopic particle imaging velocimetry system (stereo-PIV) was put into operation to investigate the cross-sensitivity regarding the varying refractive in-

dex field, e. g. in two-phase flows and flames. In order to characterize boundary layer flows at large, real-scale objects such as rotor blades of running wind turbines, the evaluation of thermographic images has proceeded to obtain contactless in-process flow visualizations with low uncertainty, even in case of low thermal contrasts due to the different weather conditions. Surprisingly, not the measurement system but the measurement object was found to currently limit the measurement uncertainty.

Harvesting energy from wind is a challenging technology, which we could also experience at our visit of the Fraunhofer Institute for Wind Energy Systems in Bremerhaven. Wind turbines are important to increase the energy supply by renewable energies. Here we are proud to contribute in the characterization and the progress of wind turbines in operation.

For the first time, the Deutsche WindGuard GmbH granted an award to honor excellent student theses at BIMAQ. I am very grateful for this support and the encouragement of our future engineers. To all members, students, partners and supporters of the institute I would like to express many thanks for the contribution to the achievements in 2017/18.

Bremen, June 2018



Prof. Dr.-Ing. habil. Andreas Fischer

Vision, topics and infrastructure

The research focus of the Bremen Institute for Metrology, Automation and Quality Science (BIMAQ) is the holistic investigation of optical measurement systems, which includes the design, realization, modelling, characterization and, finally, the application of novel measurement techniques. By applying a rigorous system-based analysis of the measurement systems, the limits of measurability and the respective uncertainty principles are investigated in order to determine and to surpass the limits of state-of-the-art approaches. Beyond pure measurement tasks, automation aspects and the application of quality controls is investigated as well. However, the core competence of BIMAQ is measurement system engineering, which is a key discipline for solving technical and overall social challenges.

A key challenge is to obtain information in situ or in-process from highly unsteady or complex technical processes. For this purpose, model-based, dynamic measurement systems are a key topic of the BIMAQ research, which

includes interdisciplinary fundamental and application-oriented research on the measurement methods and their applications. Current research topics cover task from production engineering, materials science, wind energy systems and fluid mechanics.

In addition to methodical innovations for instance based on multi-sensor-system approaches, one highlight at the BIMAQ is a unique laboratory for large gear metrology with a coordinate measurement device for gears up to a few meters. This illustrates the unique BIMAQ expertise regarding the metrology of large gears and geometrical measurements with a high dynamical range. Further laboratories and equipment exist in the BIMAQ main building and the BIMAQ technical centre, for instance for the analysis of the surface topography and strain down to the nanometre scale, for thermographic flow analyses from long distances of several hundred meters and for laser-based flow measurements in optically non-cooperative fluids.





Research
Teaching
Knowledge

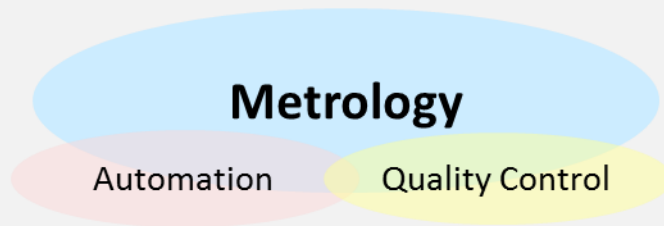

Methods

Measuring System Theory

- Modelling and Simulation
- Uncertainty Relations
- Limits of Measurability

➔ modelbased, dynamic Measuring Systems

Measuring System Technology

- Optical High Speed Measuring Systems
- Multi-Sensor-Systems
- Coordinate Measuring Systems

Application

Produktion Engineering & Materials Science

- Geometrical and Roughness Metrology
- Optical In-Process-Metrology
- Thermography, Edge Zone Analyses

Wind Power Systems & Flow Processes

- Gear Measuring Technology
- Gear Metrology
- Flow Measurement Technology

BIMAQ competences

Staff

Director

Prof. Dr.-Ing. habil. Andreas **Fischer**

Emeriti/Alumni

Prof. Dr.-Ing. Gert **Goch**

Administration

Hiltrud **Kallasch**

Sylvia **Rosenhagen**

Eva **Schultze**

Research Scientists

Dipl.-Phys. Gabriela **Alexe**

M. Sc. Matthias M. **Auerswald**

M. Sc. Christoph **Dollinger**

Dipl.-Ing. Axel von **Freyberg**

M. Sc. Martina **Fuhrmann**

M. Sc. Daniel **Gleichauf** (since 05/2018)

M. Sc. Merlin **Mikulewitsch**

M. Sc. Jan **Osmers**

M. Sc. Marc **Pillarz** (since 03/2018)

Dr.-Ing. Stefan **Patzelt** (until 02/2018)

M. Sc. Volker **Renken**

Dipl.-Ing. Michael **Sorg**

M. Sc. Johannes **Stempin**

Dr.-Ing. Dirk **Stöbener**

Dr.-Ing. Gerald **Ströbel**

Dipl.-Phys. Andreas **Tausendfreund**

M. Sc. Christoph **Vanselow**

Dipl.-Ing. Jan **Westerkamp** (until 02/2018)

Student Research Assistants

Seray **Baglar**

Mahesh **Basavanahalli Sanjeevamurthy**

Friedrich **Eickmann**

Mirco **Grimann**

Marco **Havekost**

Vinay Manjunath **Jois**

Nils **Öhlmann**

Marc **Pillarz**

Leonard **Schröder**

Kevin **Schünemann**

Marcus Jerome **Spence**

Michael **Student**

Shashank **Vasuke**

Yousaf **Zain**

Technical Assistants

Dipl.-Ing. Werner **Behrendt**

B. Sc. Marie **Dethlefs** (until 12/2017)

Thomas **Eilts**

B. Sc. Oskar **Hoppe**

Dipl.-Ing. Frank **Horn**

B. Sc. Robin **Lipinski** (until 03/2018)

Uwe **Reinhard**

Participation in scientific committees and associations

Member		Short Name	Scientific Committee / Association
	BIMAQ	AUKOM	AUKOM Ausbildung Koordinatenmesstechnik e. V.
	BIMAQ	FQS	Forschungsvereinigung Qualität
Andreas	Fischer	DGaO	Deutsche Gesellschaft für angewandte Optik
Andreas	Fischer	AHMT	Arbeitskreis der Hochschullehrer für Messtechnik e. V.
Andreas	Fischer	ForWind	ForWind – Zentrum für Windenergieforschung
Andreas	Fischer	MAPEX	Center for Materials and Processes
Andreas	Fischer	SPIE	The International Society for Optics and Photonic
Andreas	Fischer	EOS	European Optical Society
Andreas	Fischer	OSA	The Optical Society
Andreas	Fischer	IEEE	Institute of Electrical and Electronics Engineers
Andreas	Fischer	VDI	Verein Deutscher Ingenieure
Andreas	Fischer	GALA	Deutsche Gesellschaft für Laser-Anemometrie
Andreas	Fischer	DHV	Deutscher Hochschulverband
Andreas	Fischer		Regelungstechnisches Kolloquium in Boppard
Andreas	Fischer	SFB 747	Sonderforschungsbereich 747 Mikrokaltumformen
Andreas	Fischer	SFB TRR 136	Sonderforschungsbereich TRR 136 Prozesssignaturen
Andreas	Fischer	SFB 1232	Sonderforschungsbereich 1232 Farbige Zustände
Gert	Goch	WGP	Wissenschaftliche Gesellschaft für Produktionstechnik
Volker	Renken		BMW-Forschungsnetzwerke Energie: Systemanalyse, Stromnetze, Erneuerbare Energien
Michael	Sorg	DFMRS	Deutsche Forschungsvereinigung für Meß-, Regelungs- und Systemtechnik e. V.
Michael	Sorg		BMW-Forschungsnetzwerke Energie: Systemanalyse, Stromnetze, Erneuerbare Energien
Dirk	Stöbener	VDI	Verein Deutscher Ingenieure
Dirk	Stöbener	VDI FA 3.61	VDI Fachausschuss 3.61 Messen an Zahnrädern und Getrieben
Dirk	Stöbener	VDI FA 3.34	VDI Fachausschuss 3.34 Large Volume Metrology
Gerald	Ströbel	DFMRS	Deutsche Forschungsvereinigung für Meß-, Regelungs- und Systemtechnik e. V.
Gerald	Ströbel	VDI/VDE-GMA	VDI/VDE-Gesellschaft Mess- und Automatisierungstechnik
Axel	von Freyberg	FVA AK Mess-technik	Forschungsvereinigung Antriebstechnik - Arbeitskreis Messtechnik

Laboratories

LAB

Laboratory for dimensional metrology

BIMAQ's infrastructure features a variety of modern high-precision measurement systems. The equipment ranges from tactile coordinate, gearing and roughness measuring devices via optical systems like stripe pattern projection and laser triangulation through testers for non-destructive analysis with thermal, magnetic and acoustic probe systems and sensors. This equipment is used for the calibration and validation of newly developed measurement and sensor systems, e. g. for optical gear measurements, but it is also the basis for measurements within research projects and for the regional industry.

BIMAQ conducts form, size and location tests on very small to very large components by di-

mensions of a few millimeters up to 3 meters and offers standardized measurement and evaluation procedures as well as customer-specific solutions, such as the evaluation of advanced features or the digitization of a component.

Services

- Development of measurement and evaluation strategies
- Acquisition and analysis of dimensional deviations - tactile or optical
- Characterizing surface quality - tactile or optical
- Gear inspection
- Surface integrity analysis - non-destructive and non-contact
- Order/reference measurements

Contact: a.freyberg@bimaq.de



Tactile measurement of a 5-axis milled gear segment

LAB Laboratory for large gears
(in BIMAQ-Technikum)

To calibrate large gears currently no appropriate standards exist, that allow the traceability of the test processes to the SI unit "meter" with sufficient accuracy. In close cooperation with the National Metrology Institute of Germany (PTB), BIMAQ therefore is involved in developing large gear standards with a diameter of 2000 mm and more.

Furthermore, BIMAQ analyzes the cause-effect relationships between gear manufacturing, geometric deviations and occurring gearbox damages. In the field of quality inspection of gears, algorithms are being developed in order to evaluate dimensional measurement data.

Technical specifications

Portal coordinate measuring machine Leitz
PMM-F 30.20.7:

- Measuring volume:
3.0 x 2.0 x 0.7 m³
- Measuring uncertainty:
 $MPE_E = (1.3 + (L \text{ in mm})/400) \mu\text{m}$



Tactile measurement of large cylindrical gearing

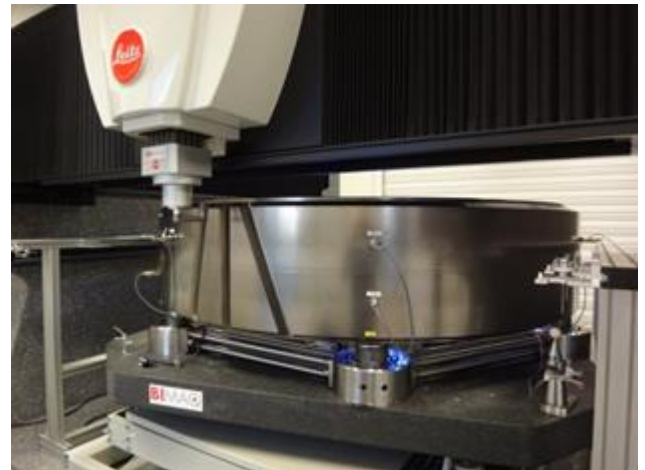

Measuring a 2 m gear standard
on BIMAQ's large CMM

- Workpiece mass:
max. 6,000 kg
- Rotary table:
for rotation-symmetric components up to
3.0 m diameter
- Air conditioning:
maximum temperature gradients
0.4 K/h, 0.8 K/d, 0.2 K/m

Services

- Order/reference measurements
- Calibration of reference standards
- Analysis and evaluation of geometric deviations
- Development of measurement and evaluation strategies
- Software development

Contact: a.freyberg@bimaq.de

Laboratories

LAB Laboratory for optical metrology

The laboratory for optical metrology works on the in-process surface assessment with scattered light measurement methods, e. g., to determine the (primarily) mechanical workpiece loads during manufacture.

The light scattering methods with coherent light on surfaces make use of speckle phenomena, which allow a fast in-process determination of (statistical) surface characteristics, without detecting the actual topography of the component. The procedures can be applied to investigate fast moving component surfaces in the manufacturing process.

In addition to assessing the mean roughness in the observed measurement spot, structure heights and widths as well as individual defect classes of components are possible to determine by evaluating the scattered light. This can be applied not only for structures with sizes above the optical wavelength, but also for structures in the nanometer range (below the

optical wavelength) by using the rigorous scattering theory based on the Maxwell equations. The derived measurement methods are investigated with simulative and experimental approaches leading to results about measurement resolution and uncertainty for specific applications as well as general limits of measurability.

Services

- Feasibility studies on the application of measurement principles, particularly in manufacturing and heat treatment processes
- Basic research regarding the development, characterization and application of novel measurement methods
- Analysis of measurement uncertainty budgets by simulative and experimental means
- Development of measuring methods for industrial applications
- Simulation and measurement of light scattering on micro- and nano-structured workpieces to assess the structural quality

Contact: d.stoebener@bimaq.de

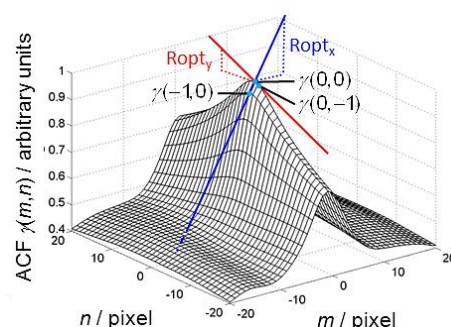
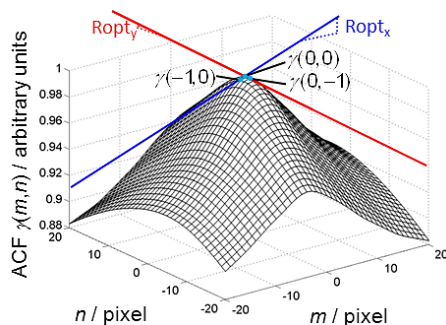

Roughness evaluation of two surfaces with speckle-autocorrelation function

LAB Laboratory
for flow metrology

The three velocity components of a flow field can be determined in a measurement plane with a stereoscopic particle image velocimetry (PIV) system, which is the centerpiece of the laser-based flow metrology laboratory. The particle-based measurement technique is applied in challenging conditions, e. g., hot jet flows, flame flows or two-phase flows. The main research topic is to quantify the measurement uncertainty caused by the influence of inhomogeneous refractive index fields. These fields lead to varying image distortions and, thus, measurement deviations of the particle position. The uncertainty budget for the determined velocity fields are obtained from model-based error propagations of the simulative and experimentally investigated refractive index field. The analysis of the

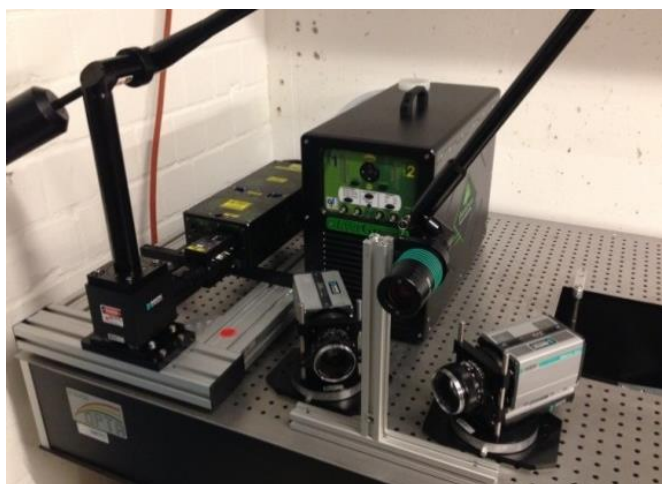

Stereoscopic PIV system

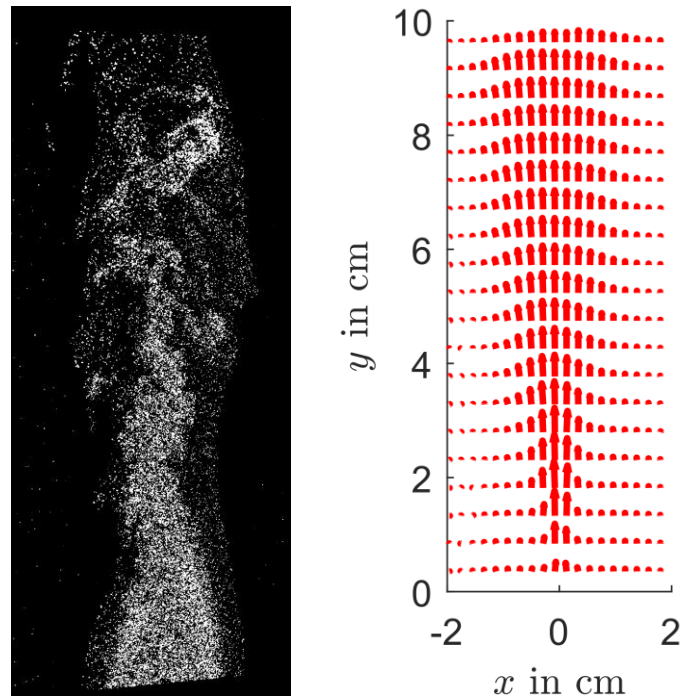

PIV raw image (left) and mean velocity field (right) of a flame flow

measurement uncertainty budget is a key topic to identify and finally overcome fundamental limits of measurability.

Technical data

Dual-head PIV-Laser (Quantel Evergreen):

- pulse energy: 2×200 mJ
- wavelength: 532 nm
- pulse rate: 15 Hz
- pulse length: <10 ns
- light guide arm: 2.1 m

$2 \times$ sCMOS cameras (Andor Zyla):

- resolution: 5.5 Mpixel
- pixel width: $6.5 \mu\text{m}$
- dynamic: 16 bit

Contact: c.vanselow@bimaq.de

Laboratories

LAB Laboratory for thermography

Boundary layer visualization on wind turbine rotor blades in operation

The boundary layer flow influences the temperature distribution on the surface of a rotor blade, which can be detected by a high speed thermographic imaging system. BIMAQ offers thermographic measurements of rotor blades on wind turbines in operation. Measurements are conducted in cooperation with the Deutsche WindGuard Engineering GmbH in Bremerhaven. Measurements can be performed from a distance between 60 m and 500 m.

Technical data

ImageIR thermographic imaging system:

- High speed IR imaging system
- Thermal resolution: 0.025 K
- Spectral range: 2 – 5 μm
- Detector format: 640 x 512 pixel
- Focal length incl. telephoto lens: 200 mm
- Integration times between 1 μs and 1600 μs



ImageIR thermographic imaging system

Services

- Determination of the laminar/turbulent transition location
- Detection of early laminar-turbulent transition due to leading edge contamination, erosion, manufacturing irregularities or the effects of leading edge protection
- Analysis of impact of leading edge protection on the boundary layer flow
- Inspection of vortex generators, zig-zag tapes and other flow control devices
- Investigation of the feasibility of anti-icing and de-icing systems

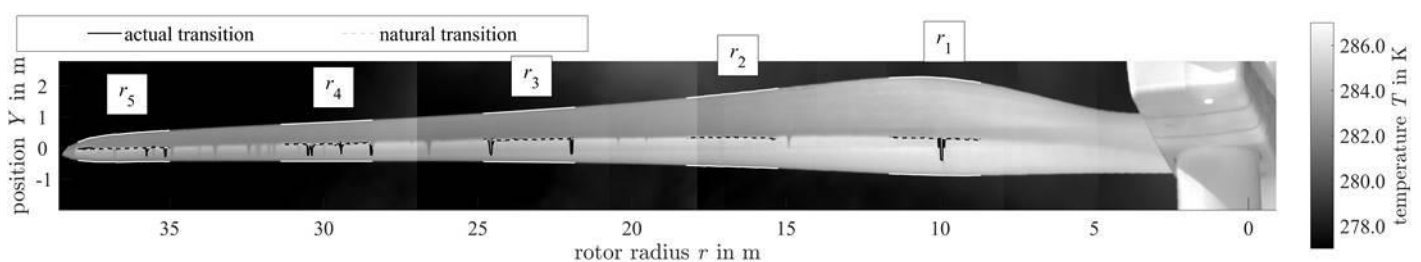

Evaluated thermographic image of the rotorblade of an
1.5 MW wind turbine with a 77 m rotor diameter

Boundary layer visualization in wind tunnel experiments

In order to investigate the boundary layer flow phenomena on airfoils, thermographic measurement approaches are developed and applied. The research focus are new image evaluation techniques based on the flow dynamics. The flow experiments with two different IR imaging systems are performed at the Deutsche WindGuard's aeroacoustic wind tunnel in Bremerhaven, where laminar air flows at speeds of up to 360 km/h and chord-Reynolds numbers of up to 6 million can be generated.

Technical data

VarioCam hr:

- Detector format: 640 x 480 pixel
- Thermal resolution: 0.030 K
- Spectral range: 7.5 - 14 μm
- Focal lengths: 12.5 mm and 30 mm

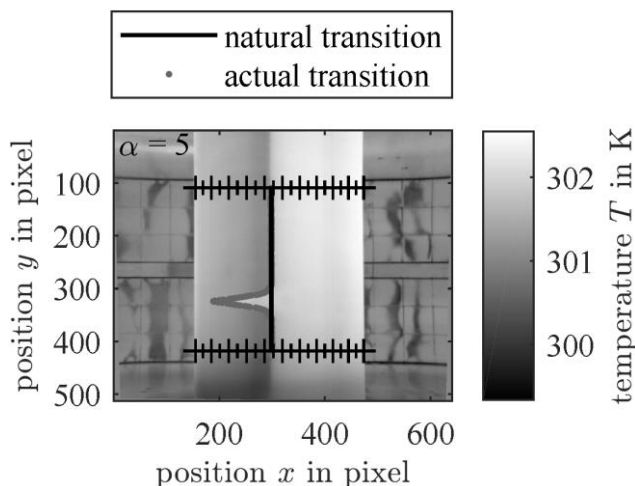

Thermographic flow visualization on an airfoil in the wind tunnel

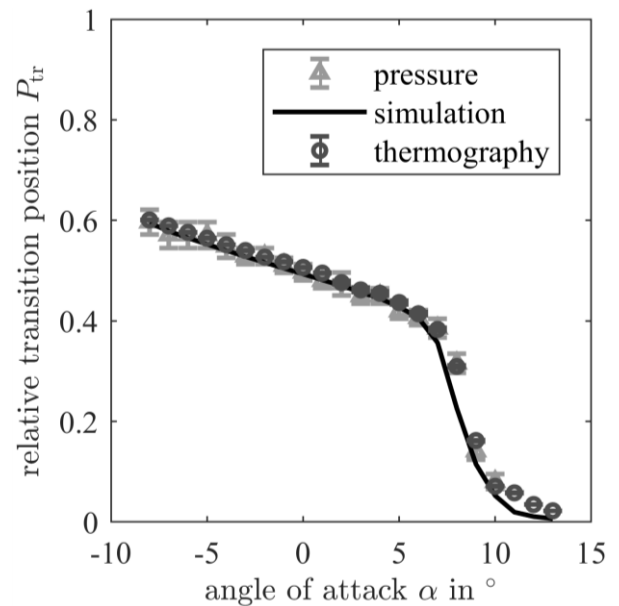

Relative position P_{tr} of the laminar-turbulent transition on the chord as a function of the angle of attack α

ImageIR:

- Detector format: 640 x 512 pixel
- Thermal resolution: 0.025 K
- Spectral range: 2 - 5 μm
- Focal lengths: 12 mm, 25 mm, 100 mm and 200 mm

Services

- Localization of the laminar-turbulent transition with a measurement uncertainty < 0.5 % chord length
- Visualization of flow separations
- Automated evaluation of wind tunnel campaigns
- Comparison with reference measurements and simulation data

Contact: c.dollinger@bimaq.de
d.gleichauf@bimaq.de

Laboratories

LAB

Laboratory for inside-sensing (in BIMAQ-Technikum)

Wind turbine generators (WTG) are dynamically highly stressed, which can lead to bearing and gear damages. For targeted improvements in design, production and choice of material meaningful metrics are missing. The individual transmission components (gears, bearings, shafts) are metrologically not accessible during operation, so far. A few states can be observed from the



Drivetrain inside the hub of a wind energy system

outside, e. g., temperature changes on the housing or noises or vibrations. But, the causes of problems are mostly inside the gear housing. These include mechanical stresses which may lead to undue distortion of the individual teeth and subsequently to wear of the tooth flanks.

For testing new sensor concepts for WTG drivelines, the dynamic behavior of WTG drivelines can be simulated experimentally in the BIMAQ-Technikum using a torque test rig.

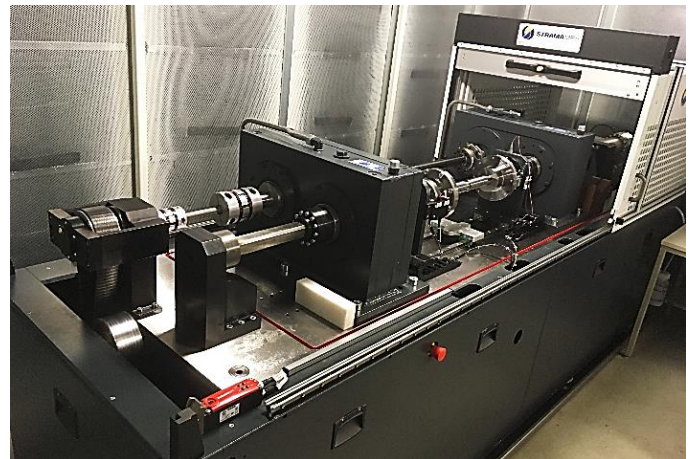

Torque test rig

Technical test rig specifications

- Torque: $\pm 1\,000\text{ Nm}$
- Speed: $\pm 3\,000\text{ min}^{-1}$
- Axial force: $0 - 10\,000\text{ N}$

Services

- Development of sensing prototypes
- Order and reference measurement
- Development of new measurement and evaluation strategies
- Software development

Contact: m.sorg@bimaq.de

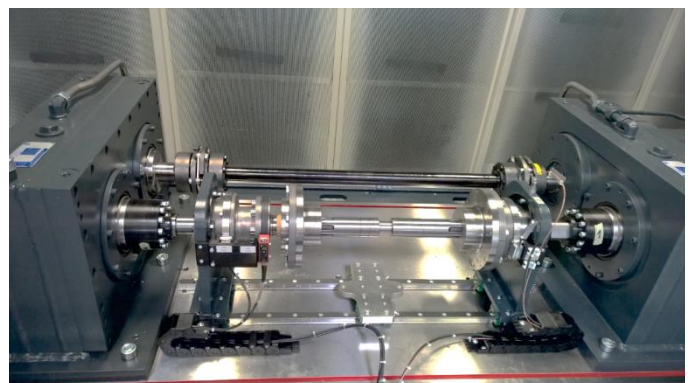

Measuring shaft in the test rig

BIMAQ maintains a 400 m² Technikum to support the research work.

The Technikum contains the

- Laboratory for large gears
- Torque test rig
- Experimental field
- Mechanical workshop



Mechanical workshop



For the production of test rigs, test stands and prototypes, the mechanical workshop is equipped, for example, with a

- CNC milling machine
Travel distance: 400 mm x 400 mm x 400 mm
- 3D printer
Space: 203 mm x 203 mm x 152 mm
- Milling drill plotter
Maximum material size:
229 mm x 305 mm x 35 mm

Services

- Item and small-batch production
- Additive and cutting machining

Contact: a.freyberg@bimaq.de

SFB 747 Micro Cold Forming - Subproject A5

Controlled scalable laser removal procedure for the manufacturing of contoured micro forming tools

Funding organization: DFG/SFB

Funding ID: SFB 747 Mikrokaltumformen

Duration: 1 Jan 2007 - 31 Dec 2018

Project scientist: Merlin Mikulewitsch

Laser chemical machining (LCM) is a novel procedure used to manufacture micro forming tools from hard metals with relatively low cost compared to competing micro-machining processes such as micro-milling or micro electrical discharge machining. The material is removed by an etchant that is chemically activated by heat from a focused laser beam, localized at the

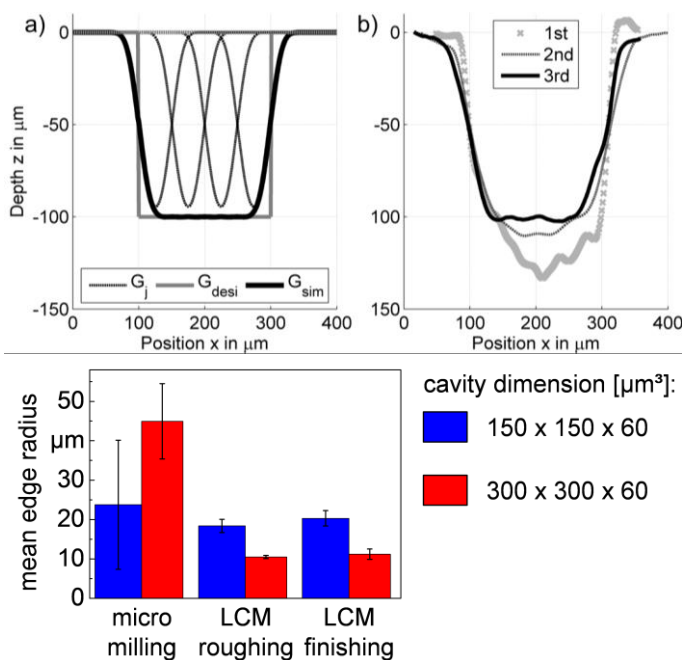

Top: Path plan for a rectangular die (left) & cross section of manufactured geometry after 3 control steps (right)

Bottom: Mean edge radii of LCM and micro milling manufactured with laser chemical machining

area of incidence, to produce the desired geometry.

The project aims to evaluate and improve the process capability of laser chemical machining in addition to reducing irregularities and dimensional deviations inherent in the etching process. In order to master a stable and reproducible production of micro forming tools without manual determination of the optimal process parameters, an adaptive control system is developed. Integrating the control system in the LCM process reduced the flatness deviation of a rectangular micro die (top figure) from about 33 μm to less than 3 μm. The comparison with competing manufacturing methods such as micro milling shows LCM to be able to achieve much smaller and less dispersed edge radii (bottom figure). The manufacture from materials without a passivation layer introduces a constant background removal that is not fully characterized and is as such focus of ongoing research.

Literature

- [1] P. Zhang, A. von Freyberg, A. Fischer: Closed-loop quality control system for laser chemical machining in metal micro-production. *International Journal of Advanced Manufacturing Technology* 93(9-12):3693-3703, 2017.
- [2] P. Zhang: Qualitätsregelungssystem eines laserchemischen Ätzprozesses für die metallische Mikroproduktion. Dissertation. Universität Bremen, Fachbereich Produktionstechnik, 2018.
- [3] H. Messaoudi, F. Böhmermann, M. Mikulewitsch, A. von Freyberg, A. Fischer, O. Riemer, F. Vollertsen: Chances and Limitations in the Application of Laser Chemical Machining for the Manufacture of Micro Forming Dies. 5th Int. Conference on New Forming Technology, Bremen, 18 Sep 2018. (accepted for publication)

SFB 747 Micro Cold Forming - Subproject B5

Quality inspection and logistic quality control for micro production processes

Funding organization: DFG/SFB

Funding ID: SFB 747 Mikrokaltumformen

Duration: 1 Jan 2007 - 31 Dec 2018

Project scientists: Axel von Freyberg,
Matthias Auerswald

Micro cold forming poses two challenges for the quality inspection process: On the one hand, the parts and geometrical features to be tested have sub-millimeter dimensions and request high dynamic ranges of the measuring systems; on the other hand, the forming processes produce parts in a high clock rate, which limits the time available for measuring and evaluating the individual parts. To cope with these conditions, the collaborating institute

BIAS is developing a digital holographic measuring system within this project to acquire geometric data of the part's surface.

In contrast to conventional dimensional metrology, the optically acquired surface data represents a combination of geometric elements, which has to be separated into individual objects prior to the evaluation of geometric deviations and parameters. For this purpose, algorithms have been developed for an automated holistic approximation of the combined geometric elements, including the ideal decomposition of these elements (see figure). This new approach is currently being adapted to combinations of higher order geometric elements (e. g. ellipse, parable etc.) to address the increase of complexity within the SFB 747.

Literature

- [1] A. von Freyberg, A. Agour, R. B. Bergmann, A. Fischer: Geometrische Auswertung digital holographischer Messungen im Bereich des Mikrokaltumformens. 8. Kolloquium Mikroproduktion, Bremen, 27 - 28 Nov 2017, pp. 13-20.
- [2] A. von Freyberg, A. Fischer: Automatic geometry segmentation of involute flank regions. International Conference on Gears: 1015-1024, 2017.
- [3] A. von Freyberg, A. Fischer: Automatische Geometrie-Dekomposition von 3D Punktwolken. Sensoren und Messsysteme 2018, Nuremberg, 26 - 27 Jun 2018, No. 3.5.4. (4 pp.)

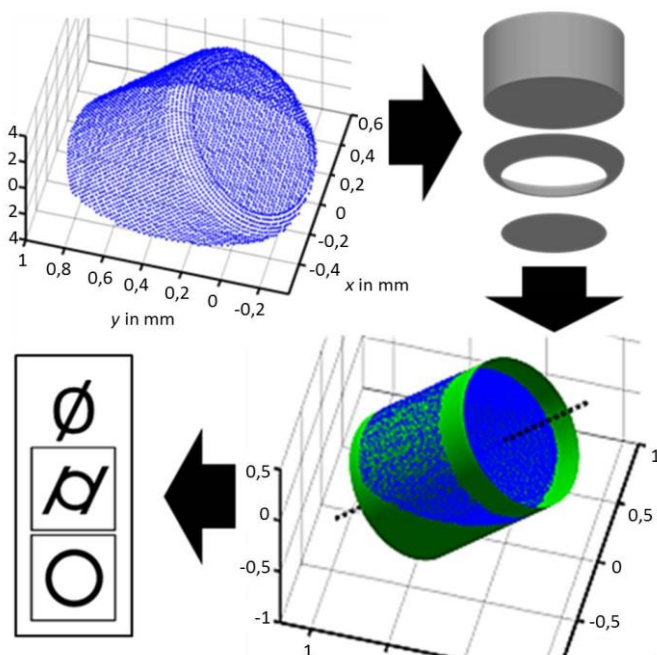

Geometric decomposition and approximation

SFB 747 Micro Cold Forming - Subproject B9

In-situ geometry measurement using confocal fluorescence microscopy

Funding organization: DFG/SFB

Funding ID: SFB 747 Mikrokaltumformen

Duration: 1 Aug 2017 - 31 Dec 2018

Project scientist: Merlin Mikulewitsch

The in-situ geometry acquisition of microstructures in manufacturing processes such as Laser Chemical Machining (LCM) places special demands on optical measuring systems, since the measured objects are surrounded by a fluid. Confocal fluorescence microscopy was previously used to increase the measurability of

metallic surfaces with strong curvatures. For this purpose, the stronger scattering fluorescence of a thin fluorophore coating $< 100 \mu\text{m}$ was detected. The signal drop at the boundary layers between the measuring object and air thus determined the surface position. The detection of thicker layers ($> 1 \text{ mm}$), as in the in-situ application of the LCM process, shows strong dependencies on the parameters fluorophore concentration and fluid depth, unlike in thinner layers. The evaluation therefore requires a physical modeling of the fluorescence signal (top figure).

To show the suitability and potential of fluorescence microscopy for the in-situ measurement of geometry parameters the step height of a submerged reference step was determined by measuring the surface positions along a lateral line (bottom figure). Ongoing research focuses on characterizing the fundamental limits and causes of measurement uncertainty in order to optimize the measurement system for actual in-situ applications on manufacturing processes such as LCM.

Literature

[1] M. Mikulewitsch, M. Auerswald, A. von Freyberg, A. Fischer: Geometry Measurement of Submerged Metallic Micro-Parts Using Confocal Fluorescence Microscopy, Nanomanufacturing and Metrology (2018). (accepted for publication)

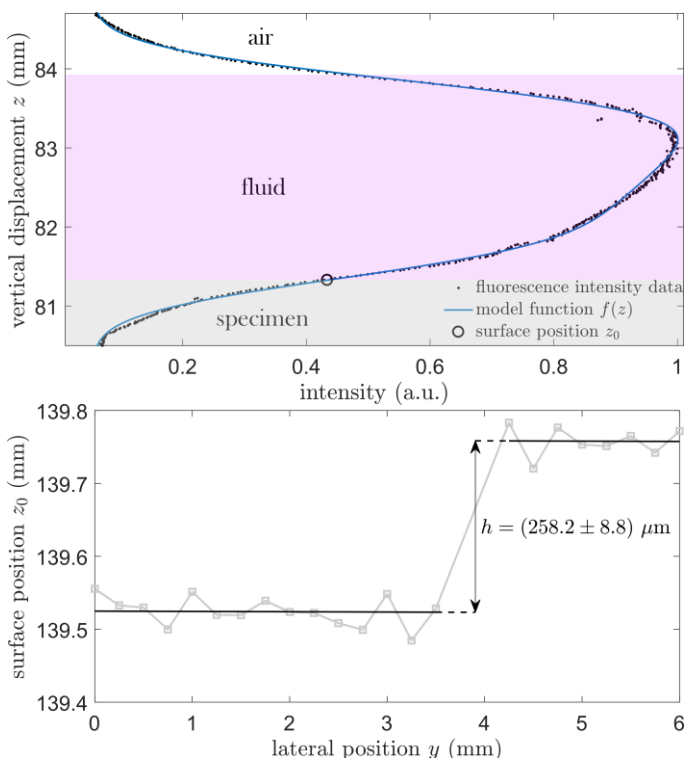

Top: Measured fluorescence intensity signal (black), fitted model function (blue).

Bottom: Surface positions of a reference step profile to determine the step height.

SFB/TRR 136 Process Signatures - Subproject C04

In-situ measurement of mechanical and thermal material loads

Funding organization: DFG/SFB

Funding ID: SFB Transregio 136

Duration: 1 Jan 2014 - 31 Dec 2017

Project scientist: Andreas Tausendfreund

Production processes, such as deep rolling or grind strengthening try to manipulate the specific surface layer properties of the workpiece in a deliberate manner. For this, a comprehensive knowledge of the physical stresses during

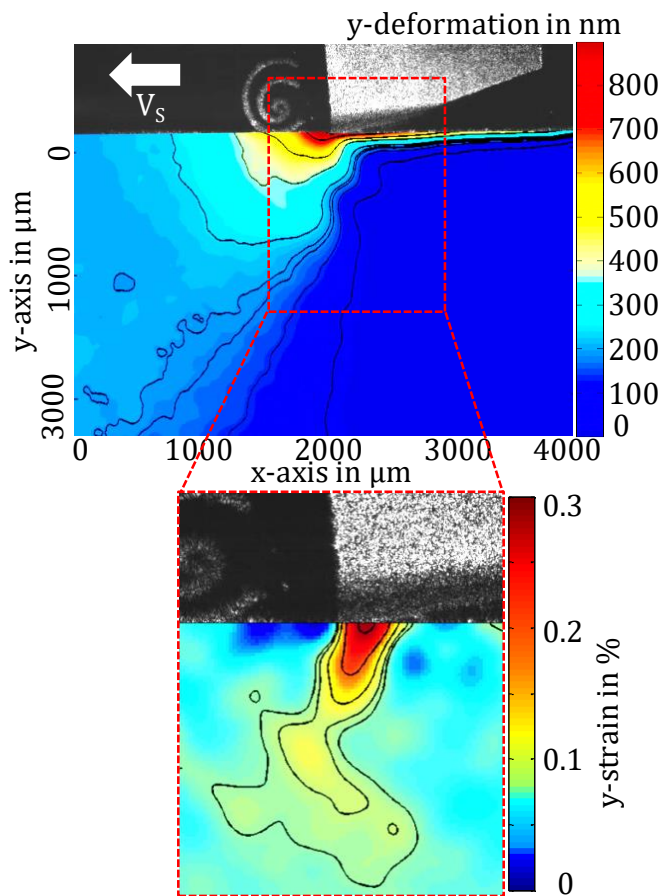

Elastic deformation and strain in a single tooth milling process

the machining is necessary. The interesting properties, like hardness and elastic modulus, are strongly influenced by plastic and elastic deformation. However, the measurement of elastic deformations in a running production process is complicated. Speckle correlation methods in principle offer the potential to meet this challenge. It could be shown that speckle correlation methods are suitable to measure under the rough production conditions with sufficient measurement resolution.

Deformation measurements during tooling succeed with the aid of a high-speed camera and a laser short-pulse exposure. Evaluation algorithms, specially adapted to the various production processes, recognize and eliminate disturbing influences such as for example particle or spark flight. The resulting elastic and plastic deformations can be reconstructed with a local resolution of 20 nm. This makes it possible for the first time, to observe the dynamic material deformations and strains in a milling process.

Literature

- [1] A. Tausendfreund, D. Stöbener, S. Patzelt, G. Ströbel, A. Fischer: In-Prozess-Verformungsmessung auf Basis von Speckle-Korrelationsverfahren. AHMT 2016, Hannover, 15 - 16 Sep 2016, pp. 201-207.
- [2] A. Tausendfreund, D. Stöbener, G. Dumstorff, M. Sarma, C. Heinzel, W. Lang, G. Goch: Systems for locally resolved measurements of physical loads in manufacturing processes. CIRP Annals 64(1):495-498, 2015.
- [3] A. Tausendfreund, D. Stöbener, G. Ströbel: In-process measurements of strain fields during grinding. euspen 2016, Nottingham/UK, 30 May - 3 Jun 2016, pp. 85-86.

SFB/TRR 136 Process Signatures – Subproject C06

Surface-based optical measurements of mechanical material stresses

Funding organization: DFG/SFB

Funding ID: SFB Transregio 136

Duration: 1 Jan 2018 - 31 Dec 2021

Project scientist: Andreas Tausendfreund

In the first phase of the SFB, the suitability of Speckle photography for in-process measurements in highly dynamic manufacturing processes was demonstrated (see precursor project C04). Specially adapted evaluation algorithms and measuring systems were developed for this purpose, so that the use of speckle photography could also be realized on fast-rotating systems such as single-tooth peripheral milling or grinding under strong flying sparks.

Three-dimensional deformations of the measured surface cannot be measured yet. This problem is to be solved by a novel approach for in-process measurements based on an analysis of the shape-modified speckle correlation functions. In addition to this three-dimensional reconstruction of the deformation fields, a central aim of the project is to determine parameters for establishing process signatures from the time-resolved stress fields measured in highly dynamic manufacturing processes. In this connection a quantification of the measurement uncertainty budget and a reduction of significant measurement uncertainty contributions are planned. In addition, data analysis is to be accelerated, for example by parallelization ap-

proaches. This enables longer studies of the workpiece dynamics as well as in-process controls in the future.

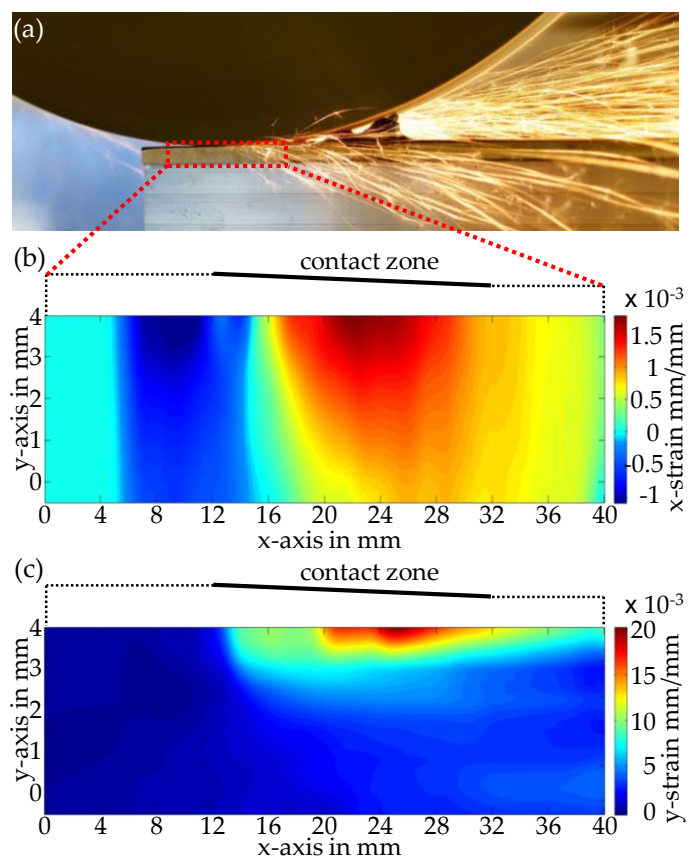

Figure 1: Dry grinding process with strong flying sparks (a) and Speckle photographic determination of the total strain (b) in feed direction and (c) in normal direction occurring during machining.

Literature

- [1] A. Tausendfreund, D. Stöbener, A. Fischer: Precise In-Process Strain Measurements for the Investigation of Surface Modification Mechanisms. *Journal of Manufacturing and Materials Processing* 2(9):1-11, 2018.
- [2] A. Fischer: Fundamental uncertainty limit for speckle displacement measurements. *Applied Optics* 56:7013-7019, 2017.

SFB 1232 Coloured states – Subproject D04

Characterization of coloured states by measuring the deformation history during forming

Funding organization: DFG/SFB

Funding ID: SFB 1232/1 - 2018

Duration: 1 Apr 2018 - 30 Jun 2020

Project scientists: Dr. Dirk Stöbener, Gabriela Alexe

The SFB initiative "From colored states to evolutionary structural materials" is developing a new experimental method of material design. The overall goal is to find efficient and targeted compositions and process chains for new metallic construction materials that meet a specific requirement profile. This novel high-throughput approach is based on new methods for the original forming, coloring and characterization of microscopic material samples, sample logistics and mathematical and computer methods for the analysis of large amounts of data. Microscopic, easy-to-manufacture samples are examined for so-called descriptors using adapted short-term characterization methods. The transfer of the determined descriptors to the macroscopic material properties of the requirement profile is carried out by a heuristic predictor function, which only requires a few macro samples.

The classical tensile test is a standard method of material characterization and provides properties such as yield strength and strain hardening. The aim of this subproject is to investigate a comparable method for micro samples. Com-

pressive stresses can be introduced into the sample by means of electro-hydraulic forming. These should lead to approximately uniaxial, homogeneous tensile stresses through a targeted deflection of the material flow in local areas. The strains resulting from the tensile stresses are recorded in situ through an optical access in the tool using the high resolution speckle photography method. From the strain data, supplemented by the applied force or energy and comparative material data from simulations, meaningful descriptors for use in predictor functions are formed.

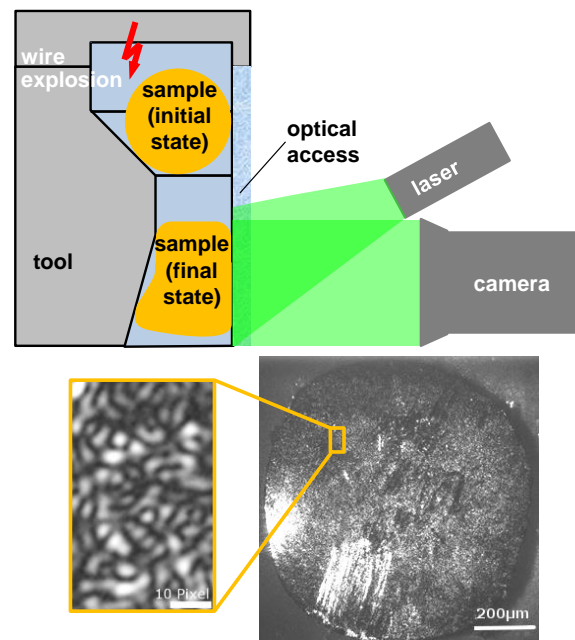

Schematic test setup in cross section and photo of a deformed sample with pronounced speckles

Literature

- [1] L. Langstädtler, H. Pegel, M. Herrmann, C. Schenck, D. Stöbener, J. F. Westerkamp, A. Fischer, B. Kuhfuß: Electrohydraulic extrusion of spherical bronze (CuSn6) micro samples. 8th International Conference on High Speed Forming, Columbus, Ohio/USA, 13 - 16 May 2018. (10 pp.)

MethodMess

Method development for measuring procedures for the in-process-characterization of sub-100-nm-structures

Funding organization: DFG

Funding ID: GO 554/35-1

Duration: 1 Apr 2015 - 30 Sep 2018

Project scientist: Gabriela Alexe

More and more applications from nanotechnology are finding their way into mass production. One of the biggest challenges is the adequate process management, resulting in an increasing need for suitable in-process measuring methods for rapid quality testing and process control. Theoretical considerations show that scattered light distributions of illuminated surfaces also contain information about existing nanostructures. Due to their fast, integral and non-contact data acquisition, scattered light measurement

methods are predestined for in-process measurements on nanostructured systems.

The aim of this project was the realization of a simulation-assisted methodology for the design of in-process scattered light measuring methods for nanostructured surfaces with sub-wavelength dimensionality, developed for several specific applications. Light scattering distributions for intact and defective surfaces were rigorously calculated and the scattering features connected to specific defects were determined with statistical relevance. Machine learning approaches (non-negative matrix approximation) supported the feature extraction. Whether for stochastic or periodical structures, fast measuring methods to unambiguously distinguish the defective surfaces can be this way configured without a comprehensive experimental effort (see figure).

For the case of subwavelength sinusoidal gratings formed in a roll-to-roll procedure, an evaluation algorithm for the grating height was developed, able for inline application. Offline measurements resulted in measurement uncertainties for the grating height of ≤ 12 nm, with a potential for < 4 nm.

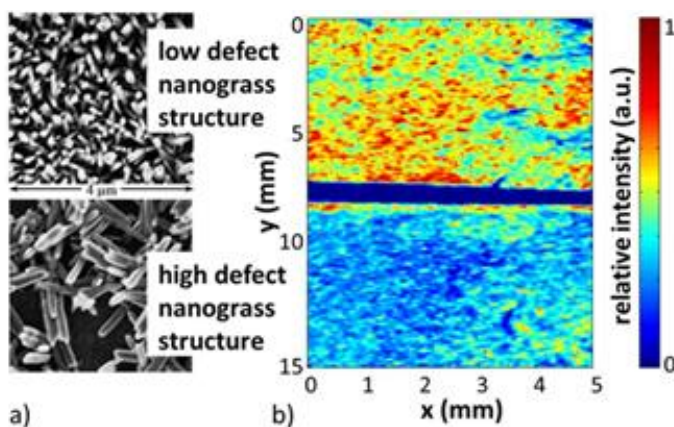

- a) Exemplary SEM images of intact and defective nanoglass-structured surfaces.
- b) Measured scattered intensities during a large area simultaneous scan over an intact and a defective nanoglass structure.

Literature

- [1] G. Alexe, A. Tausendfreund, D. Stöbener, A. Fischer: Model-assisted measuring method for periodical sub-wavelength nanostructures. *Applied Optics* 57:92-101, 2018.
- [2] D. Stöbener, G. Alexe, A. Tausendfreund, A. Fischer: Methode zur Erfassung periodischer Sub-Wellenlängen-Nanostrukturen für den In-Prozess-Einsatz. *tm - Technisches Messen* 85(2): 88–96, 2018.

Multisensory measurement of the geometry of large gears

Funding organization: DFG

Funding ID: FI 1989/2-1

Duration: 1 Mar 2018 - 28 Feb 2021

Project scientist: Marc Pillarz

The acquisition of geometric characteristics of large gears is of great importance for a quality inspection. With increasing gear dimensions, the required dynamic range of the measuring system is constantly rising. While the tolerances increase with increasing diameter and modulus of a gear, the ratio of the required measuring uncertainty to the measuring volume decreases. For the evaluation of the total profile deviation, related to the gear diameter, large gears require a measurement uncertainty which must be one order of magnitude smaller than with a small gear.

Current measuring standards for geometric features of gears, coordinate and gear measuring machines, reach their limits with large gears. The data acquisition of the probed points is serial, which leads to long measuring times. Furthermore, they have an individually limited measuring volume, which hinders scaling. In addition, the size and mass of the components increase the logistical effort for handling. Alternative measurement approaches, however, do not yet achieve the required measurement uncertainty.

For this reason, the aim of the research project is to determine geometric features (base circle radius r_b) of large gears using a novel,

model-based measuring approach in combination with a multi-sensor system of optical distance sensors.

The measuring system can be scaled to the required measuring volume by a modular and model-based design. The measuring time can be reduced by the simultaneous detection of several surface points with fast sensors. The required dynamic range of the individual sensors is also subject of the investigations, since an increase in the measuring range is typically accompanied by a greater measurement uncertainty. As a result, for a large gearing with a diameter of 2 m, a measurement uncertainty of the form parameter $< 5 \mu\text{m}$ should be achieved.

Literature

[1] A. Fischer: Fisher information and Cramér-Rao bound for unknown systematic errors. *Measurement* 113:131-136, 2018.

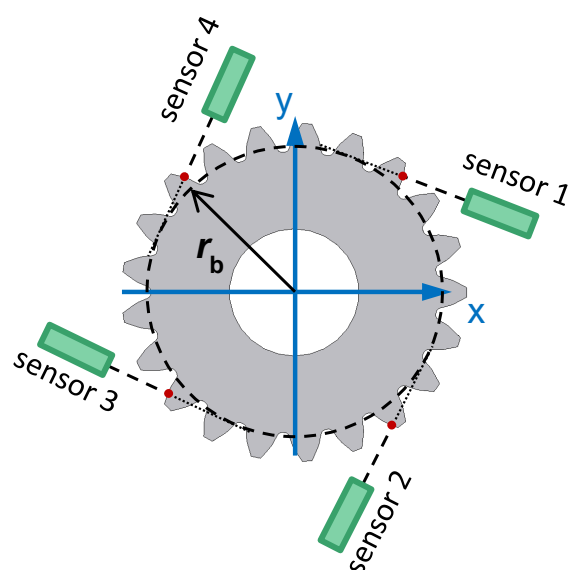

Principle sketch of the multisensory measuring approach for large gears to determine the base circle radius

Model-based quality control for zero-defect production in a thermo-forming process

Funding organization: AiF

Funding ID: 19336 N

Duration: 1 Feb 2017 - 31 Jan 2019

Project scientist: Johannes Stempin

The objective of this project is the development of a three level quality control with adaptive modules. In combination with suitable sensors and empirical values stored in databases, this quality control will enable a zero-defect thermo-forming production.

The innovation is to consider the workpiece quality as control variable. Thereby, the inner quality of the workpiece as well as its geometry is being controlled in-situ. The required technologies, in particular a deep understanding about the influences of workpiece heating, the press power and workpiece positioning, will be devel-



Fiber composite clips of aerospace industry
(source: Faserinstitut Bremen e.V.)

oped and implemented. Within this system, the quality control compensates quality deviations, which occur within the first production steps, by parameter adaptations in the subsequent sub-processes. Thus, the quality features of the workpieces finally meet the tolerances.

Sensors will acquire the process parameters and environmental effects in-process, and this data is being analyzed in parallel to realize a closed-loop control. Based on a reference variable generator, a quality controller and sensor data, the three level quality control will be implemented in one system. This control system leads to a reproducible and high workpiece quality, and, at the same time, reduces the reject rate while adapting the process to new workpieces or geometry variations. The functionality of the quality controller is the capability to predict how the process parameters affect the workpiece quality and to automatically adapt these parameters in case of imminent exceeding tolerances.

The implementation and demonstration of the project results are carried out in the frame of a thermo-forming process for the production of thermoplastic fiber composite workpieces, as their material behavior requests a strict compliance of the process parameters.

Literature

[1] J. Stempin, A. Fischer: Regelungsstrategien für einen Thermoformprozess. 52. Regelungstechnisches Kolloquium, Boppard, 21 - 23 Feb 2018, pp. 13-14.

Seltonometer for the determination of intraocular pressure with acoustic vibration excitation - evaluation algorithms and system integration

Funding organization: Federal Ministry BMBF

Funding ID: 13GW0054C

Duration: 1 Oct 2014 - 31 Mar 2018

Project scientist: Jan Osmers

Although glaucoma is the world's most common cause of irreversible blindness, there is no curative therapy available to date. Therefore early diagnosis is essential with the goal of preserving vision. The major risk factor that can be influenced in order to stop disease progression is the eye pressure (IOP). A novel IOP measurement principle for a handheld non-contact self-tonometer shall be validated.

A pressure pulse generated by a loudspeaker causes the eye to vibrate. A closed pressure chamber is placed on the human orbit in order to



Seltonometer for clinical trials at the University Hospital Würzburg, Department of Ophthalmology

reach the required sound pressure. With a microphone and a displacement sensor the dynamic behavior of the entire system is detected. The above mentioned principle has now been analyzed in clinical trials on human subjects.

The data evaluation for the varying boundary conditions of an elderly person performing a self-measurement with the shown device resulted in a challenging task. The extracted parameters from the measurements have been combined with biometrical parameters of the subject and forwarded to a neural network algorithm. The correlation of reference measurements and the output of the neural network is $R = 0.92$. The derived measurement uncertainty for new test data is determined to 8 mmHg, which is already in the range of available medical devices.

The clinical results provide a basis for a gentle noncontact tonometry method with great applicational prospects. The consecutive redesign and medical registration of the device is calculated by the industrial project partners.

Literature

- [1] J. Osmers, M. Sorg, A. Fischer: Intensity based optical measurement of cornea vibration. AMA Conferences - SENSOR 2017, Nuremberg, 31 May - 1 Jun 2017, No. D.3, pp. 522 - 526.
- [2] J. Osmers, Á. Patzkó, O. Hoppe, M. Sorg, A. Freyberg, A. Fischer: The influence of intraocular pressure on the damping of a coupled speaker-air-eye system. Journal of Sensors and Sensor Systems, 7:123-130, 2018.

OptOChar

Optical in-process surface characterization with hardware acceleration

Funding organization: Federal Ministry BMBF

Funding ID: 13N13535

Duration: 1 Mar 2015 - 28 Feb 2018

Project scientist: Dr. Stefan Patzelt

The quality of technical surfaces is a key factor for the overall quality of a product in many domains. According to DIN, roughness is defined by tactile measurement with a mechanical or an optical probe tip, which is time-consuming and requires laboratory conditions.

The research project developed a demonstrator measurement system for complete real time roughness measurement of specular reflecting surfaces in running production processes at velocities up to 1200 m/min (see figure). The measurement process generates and

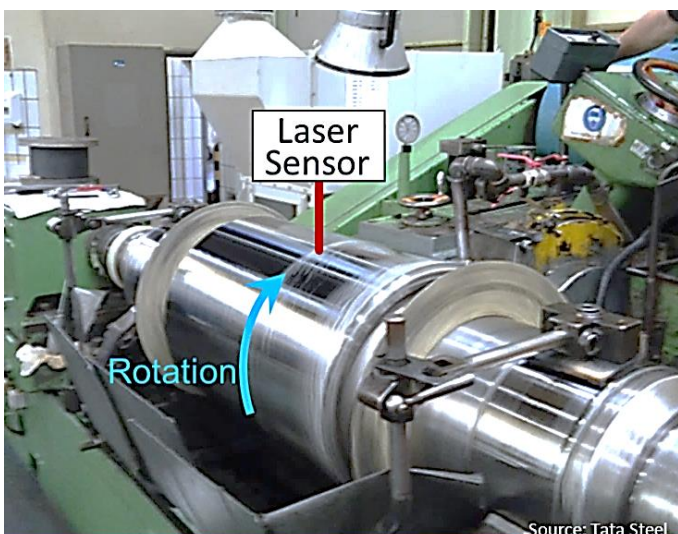

Work roll recycling and complete real time roughness measurement with a FPGA based laser sensor system

analyses scattered laser light patterns. The combination of an optimized measuring setup, adapted image processing algorithms and high performance Field Programmable Gate Array (FPGA) hardware enables for the first time a field of view diameter of 10 mm and a measuring rate up to 1.2 kHz. This results in a complete measured surface area of 4 m²/min.

Future applications of the sensor device are targeted on multiple domains, e. g. semiconductor industries, photovoltaic systems, medical systems, steel production and metal processing.

Literature

- [1] S. Patzelt, Ch. Stehno, A. Tausendfreund, G. Ströbel: Optimierter specklebasierter Rauheitsmessprozess für bewegte, spiegelnde Oberflächen. *tm - Technisches Messen* 83(9):484–493, 2016.
- [2] S. Patzelt, M. Quinten, Ch. Stehno, A. Tausendfreund, F. Houta, T. Eilts, G. Ströbel: Optimized parametric optical surface characterization process for smooth engineered surfaces. *DGaO 117th Annual Meeting, Hannover, 17 - 21 May 2016, No. B15.* (2 pp.)
- [3] S. Patzelt, Ch. Stehno, D. Stöbener, G. Ströbel, A. Fischer: In-Prozess-Charakterisierung spiegelnder Oberflächen mit Laserstreulicht und leistungsfähiger Hardware. *tm - Technisches Messen* 84(9):557-567, 2017.
- [4] S. Patzelt, D. Stöbener, G. Ströbel, A. Fischer: Uncertainty of scattered light roughness measurements based on speckle correlation methods. *SPIE, Optical Metrology, Munich, 25 - 29 June 2017, Vol. 10329, No. 103291P.* (11 pp.)

Effects of the geographical distribution and temporal correlation of wind and solar input on the power supply system

Funding organization: Federal Ministry BMWi

Funding ID: 0325695B

Duration: 1 Sep 2015 - 30 Oct 2017

Project scientists: Volker Renken, Michael Sorg

The rising penetration of renewable energies became an important issue in the German electricity sector within the past years. For some regions the renewable generation is already surpassing the power demand. Because of the geographically and temporal varying distribution of the generation of renewable energy, a geographical distribution of the energy is inevitable. In order to plan the required infrastructure for the energy distribution, a detailed

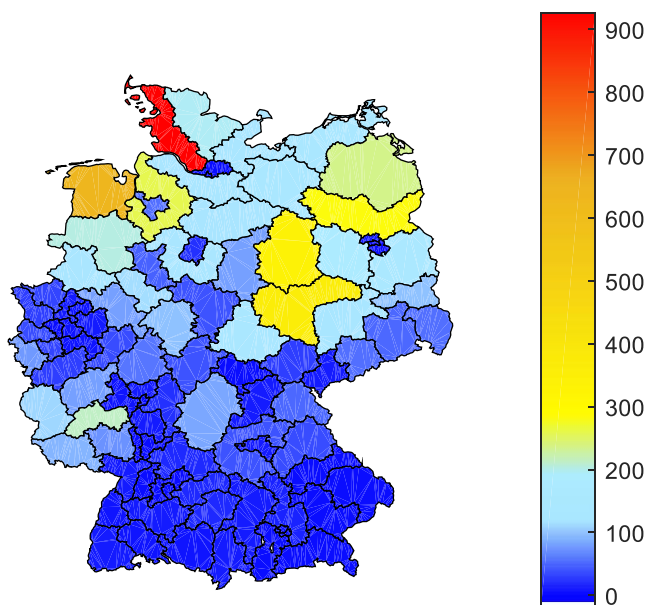

Mean wind energy generation in MW 2014
of 95 zip code regions

knowledge about the geographical and temporal power generation is crucial. However, the data availability for the distribution of the renewable power generation in Germany is insufficient due to the complexity of the energy system there are only simulation based studies available.

For this reason, a real measuring data based comparison between the renewable power generation and the electricity demand is conducted within GEOWISOL [1]. The data is given as time series of 15 minutes average values for each zip code region for wind, solar and demand quantities. For enhancing the still incomplete data, model-based data filling algorithms are introduced and compared to conventional interpolation techniques [2]. As a result, the data filling algorithms are validated and the power generation is shown to be very heterogeneous over space and time. Due to the generated measurement-based data set, infrastructure questions regarding the energy system can be answered with higher reliability.

Literature

- [1] V. Renken: Auswirkung der geographischen Verteilung und zeitlichen Korrelation von Wind- und solarer Einspeisung auf die Stromversorgung (GEOWISOL). Konferenz „Zukunftsfähige Stromnetze“, Berlin, 22 - 23 Sep 2016.
- [2] V. Renken, M. Sorg, V. Marschner, L. Gerdes, G. Gerdes, A. Fischer: Geographical comparison between wind power, solar power and demand for the German regions and data filling concepts. *Renewable Energy* 126:475-484, 2018.

BiSWind

Component integrated sensor system for wind energy systems

Funding organization: Federal Ministry BMWi

Funding ID: 0325891D

Duration: 1 Dec 2015 - 30 Nov 2018

Project scientists: Michael Sorg,
Werner Behrendt

Drive trains of wind energy systems experience a broad range of dynamic loads. Transient torque reversals originate in power loss and emergency stops, start cycles and in sheer winds and turbulence. The subsequent failure of bearings and gearboxes result in over 50 % of wind energy. To improve the design of drive train components



Research wind energy system
of the University of Bremen

with precise load cycles, precise and long-term measurements are required.

Torque sensors are currently used only sporadically and not in volume production. Direct measurements of loads are not available for most parts of the drive train, especially from the inside of the gearbox. Data over the lifetime are scarce and correlations to failure events are thus limited to a few cases.

The co-operative research project develops a component-integrated measuring system. The key design aspects are measurement of torque, temperature, vibration and rotational speed with a sensor that is resistant to aging and aggressive media, and is self-sufficient.

The scientific and technical objectives cover a broad range beginning with the process development for direct coating and structuring of resistance structures and electrodes directly on shafts for the durable sensor itself. To be self-sufficient newly developed AlN and AlScN based piezoelectric structures have to provide the energy for the sensor module which in turn will be assembled on a cylindrical low temperature co-fired ceramics. This sub-project investigates both the suitability and the performance of the measuring system for application in wind turbines.

Literature

[1] K. Tracht, G. Goch, P. Schuh, M. Sorg, J. F. Westerkamp: Failure probability prediction based on condition monitoring data of wind energy systems for spare parts supply. CIRP Annals 62(1):127-130, 2013.

In-process sensors and adaptive control systems for additive manufacturing

Funding organization: Federal Ministry BMBF

Funding ID: 02P15B076

Duration: 1 May 2017 - 30 Apr 2020

Project scientist: Volker Renken

Selective laser melting (SLM) becomes an important factor for the manufacturing of different construction parts. The technology offers variances and functionalities going beyond conventional possibilities.

However, the SLM machines possess seldom sensors to detect actual process states and have limited reaction on disturbances. That leads either to part errors and unnecessary follow-up costs or to a not optimised manufacturing procedure regarding resources and efficiency.

Aim of the project is the integration of additional sensor and control technology into the machines. Different sensors measuring intensity in visible (RGB) and infrared range (IR) as well as topography (in-process depth meter - IDM) shall be included. Therefore, the process parameters as melt pool size and temperature will be reasoned and controlled by adaptive model-based control strategies within a cascaded control structure [1]. For that purpose, techniques from machine learning are included in the control hardware. The process speed is a high challenge for the control hardware and software. In order to be able to react on measurable changes fast models and

fast hardware are needed. First results show control times of below 50 μ s [2].

Principal control ability has been shown for a proof-of-concept experiment by scanning with low scan speed over a bridge structure. Thus, a closed-loop P-controller approach leads to a reduction of temperature deviation of up to 70 % compared to open-loop control (see Figure).

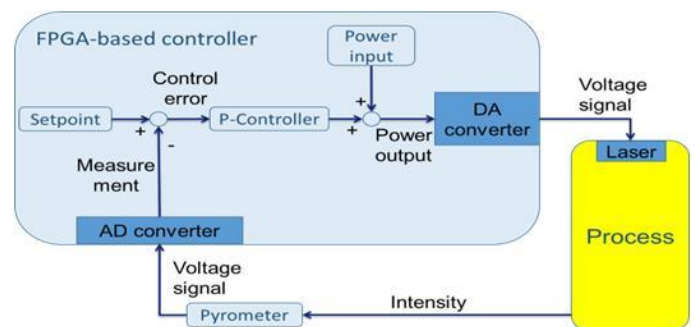

Control structure within closed-loop of manipulating the laser power by pyrometer measurement

The next steps will comprise the transfer of closed-loop algorithms to real powder-based part building jobs and increase the scan speed to realistic values for SLM process. The results are promising to stabilize melting circumstances and therefore to reduce error rates significantly.

Literature

- [1] V. Renken, S. Albinger, G. Goch, A. Neef, C. Emmelmann: Development of an adaptive, self-learning control concept for an additive manufacturing process. CIRP Journal of Manufacturing Science and Technology 19:57-61, 2017.
- [2] V. Renken, L. Lübbert, H. Blom, A. von Freyberg, A. Fischer: Model assisted closed-loop control strategy for selective laser melting. LANE 2018 10th CIRP Conference on Photonic Technologies, Fürth, 3 - 6 Sep 2018, No. 11189. (accepted for publication)

ThermoFlight

Concept for the development of an optimized maintenance and inspection method for offshore wind turbines using thermography and SHM as non-destructive testing technologies in combination with unmanned aerial vehicles

Funding organization: BIS

Funding ID: 59203/4

Duration: 1 Jan 2017 - 31 Dec 2018

Project scientist: Christoph Dollinger

The planned expansion of offshore wind energy in Germany requires the maintenance and operation to be efficiently organized both economically and ecologically for at least 25 years for a growing number of wind energy turbines. The maintenance and testing teams are confronted with new challenges offshore. This is due to short time windows as a result of difficult weather conditions as well as high safety requirements and regulations.

Especially the rotor blade tests by industrial climbers are difficult to plan under these harsh conditions. With the objective of minimizing the use of personnel for inspections and the result-

ing downtimes of the offshore wind turbines, the use of non-destructive testing methods and structural health monitoring is investigated. Especially in combination with unmanned aerial vehicles, these technologies can contribute to an efficient, safe, energy and material-optimized rotor blade inspection process.

For the nondestructive testing of the inner structure of offshore wind turbine rotor blades the potential of thermographic images taken from unmanned aerial vehicles is investigated. The resulting requirements in terms of weight and power supply limit the variety of suitable thermographic cameras and due to that affect the available spatial and thermal resolution.

In order to characterize the method, thermographic measurements, both with high-end and light-weight thermographic systems, in standstill for deep structural (see figure) and on the running wind turbine for surface near defects are performed [1]. The objective is to compensate the observed technical limitations by the use of image processing in terms of a contrast enhancement [2].

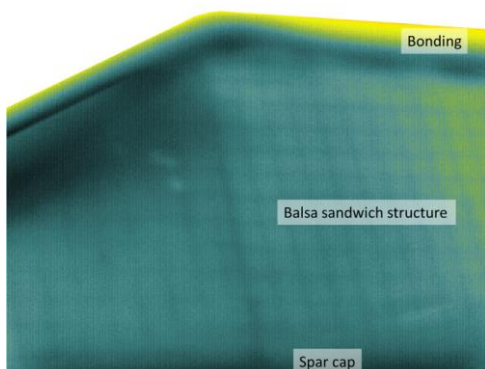

Thermographic image of the inner structure of a rotor blade

Literature

- [1] C. Dollinger, M. Sorg, N. Balaesque, A. Fischer: Measurement uncertainty of IR thermographic flow visualization measurements for transition detection on wind turbines in operation. *Experimental Thermal and Fluid Science* 97:279-289, 2018.
- [2] C. Dollinger, N. Balaesque, M. Sorg, A. Fischer: IR thermographic visualization of flow separation in applications with low thermal contrast. *Infrared Physics & Technology* 88:254-264, 2018.

Cooperations with industry and measurement services

Cooperation partners

- A**
- Aconity3D GmbH, **Herzogenrath**
 - ASENTEC GmbH, **Heilbronn**
 - AUKOM e. V., **Braunschweig**
- B**
- BIAS Bremer Institut für angewandte Strahltechnik, **Bremen**
 - BIBA Bremer Institut für Produktion und Logistik, **Bremen**
 - BIME Bremer Institut für Strukturmechanik und Produktionsanlagen, **Bremen**
- C**
- C.F.K. CNC-Fertigungstechnik Kriftel GmbH, **Kriftel**
 - CoSynth GmbH & Co. KG, **Oldenburg**
- D**
- Deutsche Wind Guard GmbH, **Varel**
 - Deutsche WindGuard Engineering GmbH, **Bremerhaven**
 - Deutsche WindGuard Systems, **Berlin**
 - DFMRS Deutsche Forschungsvereinigung für Meß-, Regelungs- und Systemtechnik e. V., **Bremen**
- F**
- Faserinstitut Bremen e. V. FIBRE, **Bremen**
 - Fraunhofer-Einrichtung für Additive Produktionstechnologien IAPT, **Hamburg-Bergedorf**
 - Formtech GmbH, **Weyhe**
 - Fraunhofer Institut für Windenergie und Energiesystemtechnik IWES, **Bremerhaven**
 - Fraunhofer-Institut für Keramische Technologien und Systeme IKTS, **Dresden**
- H**
- Fraunhofer-Institut für Organische Elektronik, Elektronenstrahl- und Plasmatechnik FEP, **Dresden**
 - FRT GmbH, **Bergisch Gladbach**
 - FWBI Friedrich Wilhelm Bessel Institut Forschungsgesellschaft mbH, **Bremen**
 - Gottwald Hydraulik, **Bremen**
 - Helmholtz-Zentrum, Institut für Fluidodynamik, **Dresden**
 - Hexagon Manufacturing Intelligence, **Wetzlar**
- I**
- IMSAS Institut für Mikrosensoren, -aktoren und -systeme, Universität **Bremen**
 - InfraTec GmbH Infrarotsensorik und Messtechnik, **Dresden**
 - ISRA VISION AG, **Darmstadt**
- K**
- K & R enatec GmbH, **Schwanewede**
 - Klingelberg GmbH, **Hückeswagen**
- L**
- Labor für Mikrozerspanung, **Bremen**
 - Leibniz-Institut für werkstofforientierte Technologien - IWT, **Bremen**
 - Lloyd Dynamo Werke GmbH, **Bremen**
- M**
- Materialise GmbH, **Bremen**
 - Meridian Lightweight Technologies United Kingdom (MLTUK), Sutton-In-Ashfield, **Nottingham/UK**
 - Micro Systems Engineering GmbH, **Berg**
- O**
- OptoPrecision GmbH, **Bremen**
 - Optris GmbH, **Berlin**

Cooperations with industry and measurement services

Cooperation partners

- P**
- Physikalisch-Technische Bundesanstalt PTB, **Braunschweig**
 - Pöppelmann GmbH & Co. KG, **Lohne**
 - Precitec GmbH & Co. KG, **Gaggenau**
- R**
- Roland Klinik Bremen gGmbH, **Bremen**
- S**
- Sachverständigenbüro Otto Lutz, **Bundorf**
 - Schaeffler Technologies AG & Co. KG, **Herzogenaurach**
 - Siegert Thinfilm Technology GmbH, **Hermsdorf**
 - Siemens AG, **Bremen**
 - SINUS Messtechnik GmbH, **Leipzig**
 - Stiftung OFFSHORE-WINDENERGIE, **Varel**
- T**
- Tata Steel Plating, Hille & Müller GmbH, **Düsseldorf**
 - Technische Universität Dresden, Institut für Festkörperelektronik, **Dresden**
- U**
- Temicon GmbH, **Dortmund**
- V**
- Technische Universität Ilmenau, Fachgebiet Elektroniktechnologie, **Ilmenau**
 - Technische Universität Ilmenau, Fachgebiet Mikromechanische Systeme, **Ilmenau**
 - Toho Tenax Europe GmbH, **Wuppertal**
 - Trecolan GmbH, **Bremen**
- W**
- Universitätsklinikum, **Würzburg**
 - VEW Vereinigte Elektronikwerkstätten GmbH, **Bremen**
 - VTD Vakuumtechnik Dresden GmbH, **Dresden**
 - Weiss Umformwerkzeuge GmbH, **Rednitzhembach**
 - wenglor sensoric GmbH, **Tett nang**
 - WindMW Service GmbH, **Bremerhaven**

Measurement services

Dimensional measurements

Duration: continuously

Contact: a.freyberg@bimaq.de

With its extensive measurement equipment, BIMAQ offers measurement services for the local industry.

The measurement tasks range from dimensional measurements on metallic and fiber composite materials for the automotive, energy, aerospace and space industry to roughness measurements on flexible sealing elements. Depending on the application, geometrical features are acquired on coordinate measuring machines with tactile or optical probes and dimensional, shape and position deviations are evaluated. Other applications require the optical acquisition of free-form surfaces by means of stripe pattern projection systems.

Roughness measurements are performed either with a stationary measuring device or with a mobile device, e. g. on bearing rings with diameters up to 2 m.

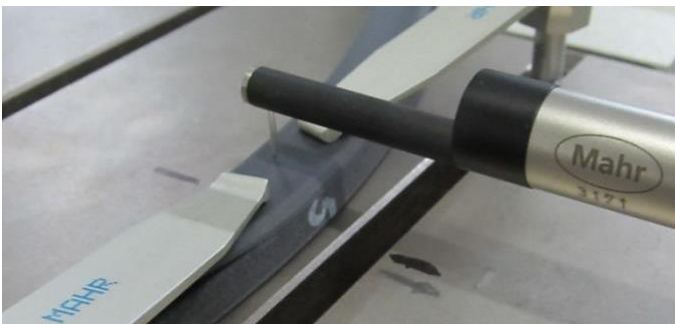

Roughness measurement on a flexible sealing element

Thermographic flow visualization

Duration: year-long

Contact: c.dollinger@bimaq.de

In a close cooperation with Deutsche WindGuard Engineering GmbH, thermographic measurements for flow visualization in wind tunnel experiments and on the rotor blades of wind turbines in operation are performed. The thermographic method for flow visualization is non-invasive and provides the location of different flow regions including the laminar-turbulent transition. The flow regions can be distinguished by differences in heat flux and temperature fluctuations in time. In wind tunnel experiments, the acquisition, the automated processing and the evaluation of the results are part of the offered services.

Combined with a telephoto lens, the high-performance IR-camera is capable to detect small temperature differences on the rotor blade surface for a visualization of the flow conditions on wind turbines in operation. The information can be determined without the expensive instrumentation of conventional methods for flow visualization. The measurements are carried out at a distance of several hundred meters and enable an overall evaluation of the flow conditions at the rotor blade as well as the study of influences by contamination and erosion of the rotor blade on the flow.

Teaching activities, student projects, graduation works

Teaching activities

Lecture	PT	SE	Wing	BB	Sem. BSc	Sem. MSc	CP	Students WiSe 17/18 and SoSe 2018
Messtechnik	●	●	○	○	3 rd		3	139
<i>Übung Messtechnik</i>	●		○	○	3 rd		1	132
<i>Labor Messtechnik</i>	●		○	○	3 rd		1	57
Regelungstechnik	●		○		5 th		3	106
<i>Übung Regelungstechnik</i>	●		○		5 th		1	100
<i>Labor Regelungstechnik</i>	●		○		5 th		1	66
Grundlagen der Qualitätswissenschaft	●	●	●		5 th	1 st	3	164
Regenerative Energien	●	○	○	○	4 th 6 th	1 st	3	45
Prozessnahe und In-Prozess-Messtechnik	●	●	●		4 th 6 th	1 st 2 nd 3 rd	3	18
Geometrische Messtechnik mit Labor * AUKOM	●	●	○		5 th	1 st	3	31
Methoden der Messtechnik - Signal- und Bildverarbeitung	●	●	●		5 th	1 st 2 nd	3	10
Einführung in die Automatisierungstechnik mit Labor	●	●	○		5 th	1 st 2 nd	3	24
Produktion von Verzahnungen (held by several chairs)	●	○				1 st 2 nd	6	21
<i>Labor Produktion von Verzahnungen</i> (held by several chairs)	●	○				1 st 2 nd	3	14
Grundlagenlabor Produktionstechnik		●			4 th		2	35

Legend:

● - Pflicht-/Wahlpflicht-/Wahlfach, ○ - fakultativ

PT - Produktionstechnik, **SE** - Systems Engineering, **Wing** - Wirtschaftsingenieurwesen Produktionstechnik,

BB - Berufliche Bildung

* -  **AUKOM** Certificate: AUKOM is a manufacturer-independent association for training in the field of geometric measurement technology. AUKOM offers the students to earn the level 1 basic certificate at cost (in total, there are 3 levels of training: 1 basic, 2 advanced, 3 expert).

Student projects

Kind of project	Title	Semester	Course of studies*
Masterprojekt	Entwicklung eines Simulationswerkzeugs zur Untersuchung biometrischer und druckabhängiger Einflüsse auf die Schwingungsdynamik des Auges	WiSe 2017/2018	MSc PT
Masterprojekt	Erprobung und potenzielle Erweiterung der Anwendungsgrenzen und -felder in der Speckle-Fotografie	WiSe 2017/2018	MSc PT
Informatikprojekt	EDV-2 Projekt: Aufbau eines 3D-Laserscanners mit Signalauswertung und Geräteansteuerung unter MATLAB	SoSe 2018	BSc PT BSc WING

*SE - Systems Engineering, PT - Produktionstechnik, WING - Wirtschaftsingenieurwesen - Produktionstechnik

Graduation works

Bachelor theses

- Maik **Hasselbusch**:
Calibration method for correcting radial distortion in thermographic measurements.
 Colloquium: 4 Apr 2018
- Dennis **Jacob**:
Parallelization approaches for evaluation algorithms of digital Speckle photography.
 Colloquium: 10 Apr 2018
- Hasan Hüseyin **Kahraman**:
Non-contact measuring systems for medical drilling methods.
 Colloquium: 25 Jul 2017
- Tim **Roggenthien**:
MATLAB-based correction of distortions and strains in thermographic data for flow visualization.
 Colloquium: 14 Sep 2017
- Marvin **Rumke**:
The influence of the inhomogeneous refractive index field over particle image velocimetry in flames.
 Colloquium: 9 Mar 2018
- Jendrik **Schaffrath**:
Development of a mechanism to determine the influence of the tightness of an acoustic tonometer on the measurement uncertainty.
 Colloquium: 16 Mar 2018
- Kevin **Schünemann**:
Model-based preparation of measurement data for controlling a selective laser melting process.
 Colloquium: 2 Nov 2017

Master theses

- Daniel **Gleichauf**:
Geometric mapping of thermographic flow visualization measurements on wind turbine rotor blades.
Colloquium: 8 Dec 2017
- Marc Christoph **Pillarz**:
Non-contact determination of the damping of the eye and its influence during dynamic intraocular pressure measurement.
Colloquium: 16 Feb 2018
- Wolf Hayo **Schleevoigt**:
Detection of defects on the ball bearing of a cup anemometer by means of a structure-borne noise analysis.
Colloquium: 2 Aug 2017
- Jeroen van **Kempen**:
Detection of material transitions and properties during medical drilling of bone.
Colloquium: 6 Mar 2018

Awards

The Young Talent Award of Deutsche WindGuard GmbH was awarded to:

- Marc Christoph **Pillarz**
Bachelor Thesis 2016: *Concept for an optical sensor for contactless detection of vibrations on the eye.*
- Wolf Hayo **Schleevoigt**
Master Thesis 2017: *Detection of defects on the ball bearing of a cup anemometer by means of a structure-borne noise analysis.*

Publications and qualification of young academics

Publications

Books

- **P. Zhang:**
Qualitätsregelungssystem eines laser-chemischen Ätzprozesses für die metallische Mikroproduktion.
In: Forschungsberichte des Bremer Instituts für Messtechnik, Automatisierung und Qualitätswissenschaft (Eds. A. Fischer and G. Goch), Vol. 1, Shaker, Aachen, 2018.

Journals

- **G. Alexe, A. Tausendfreund, D. Stöbener, A. Fischer:**
Model-assisted measuring method for periodical sub-wavelength nanostructures.
Applied Optics 57:92-101, 2018.
- **C. Dollinger, N. Balaesque, M. Sorg, A. Fischer:**
IR thermographic visualization of flow separation in applications with low thermal contrast.
Infrared Physics & Technology 88:254-264, 2018.
- **C. Dollinger, M. Sorg, N. Balaesque, A. Fischer:**
Measurement uncertainty of IR thermographic flow visualization measurements for transition detection on wind turbines in operation.
Experimental Thermal and Fluid Science 97:279-289, 2018.
- **J. Dong, H. Prekel, M. Dethlefs, J. Epp, A. Fischer:**
In-situ-Untersuchung von Randschichten während des Gasnitrierens mittels Röntgendiffraktometrie und photothermischer Radiometrie.
HTM Journal of Heat Treatment and Materials 72(3):154-167, 2017.
- **A. Fischer:**
Fundamental uncertainty limit for speckle displacement measurements.
Applied Optics 56:7013-7019, 2017. (highlighted article with excellent scientific quality, Editor's Pick)
- **A. Fischer:**
Imaging flow velocimetry with laser Mie scattering.
Applied Sciences 7(12):1298, 2017. (31 pp.)
- **A. Fischer:**
Model-based review of Doppler global velocimetry techniques with laser frequency modulation.
Optics and Lasers in Engineering 93:19-35, 2017.
- **A. Fischer:**
Angular-Dependent Radius Measurements at Rotating Objects Using Underdetermined Sensor Systems.
IEEE Transactions on Instrumentation and Measurement 67(2):425-430, 2018.

Publications and qualification of young academics

Publications

- A. **Fischer**:
Fisher information and Cramér-Rao bound for unknown systematic errors.
Measurement 113:131-136, 2018.
- J. **Gürtler**, R. Schlüßler, A. Fischer, J. Czarske:
High-speed non-intrusive measurements of fuel velocity fields at high-pressure injectors.
Optics and Lasers in Engineering 90:91-100, 2017.
- J. **Osmers**, Á. Patzkó, O. Hoppe, M. Sorg, A. von Freyberg, A. Fischer:
The influence of intraocular pressure on the damping of a coupled speaker–air–eye system.
Journal of Sensors and Sensor Systems 7:123–130, 2018.
- V. **Renken**, M. Sorg, V. Marschner, L. Gerdes, G. Gerdes, A. Fischer:
Geographical comparison between wind power, solar power and demand for the German regions and data filling concepts.
Renewable Energy 126:475-484, 2018.
- D. **Stöbener**, G. Alexe, A. Tausendfreund, A. Fischer:
Methode zur Erfassung periodischer Sub-Wellenlängen-Nanostrukturen für den In-Prozess-Einsatz.
tm - Technisches Messen 85(2): 88–96, 2018.
- A. **Tausendfreund**, D. Stöbener, A. Fischer:
Precise In-Process Strain Measurements for the Investigation of Surface Modification Mechanisms.
Journal of Manufacturing and Materials Processing 2(9):1-11, 2018.
- C. **Vanselow**, A. Fischer:
Influence of inhomogeneous refractive index fields on particle image velocimetry.
Optics and Lasers in Engineering 107:221-230, 2018.
- M. **Mikulewitsch**, M. Auerswald, A. von Freyberg, A. Fischer:
Geometry Measurement of Submerged Metallic Micro-Parts Using Confocal Fluorescence Microscopy.
Nanomanufacturing and Metrology (2018). (accepted for publication)
- S. **Patzelt**, C. Stehno, D. Stöbener, G. Ströbel, A. Fischer:
In-Prozess-Charakterisierung spiegelnder Oberflächen mit Laserstreulicht und leistungsfähiger Hardware.
tm – Technisches Messen 84(9):557-567, 2017.
- V. **Renken**, S. Albinger, G. Goch, A. Neef, C. Emmelmann:
Development of an adaptive, self-learning control concept for an additive manufacturing process.
CIRP Journal of Manufacturing Science and Technology 19:57-61, 2017.
- P. **Zhang**, A. von Freyberg, A. Fischer:
Closed-loop quality control system for laser chemical machining in metal micro-production.

International Journal of Advanced Manufacturing Technology 93(9-12):3693-3703, 2017.

Conference contributions with proceedings

- M. **Auerswald**, A. von Freyberg, A. Fischer:
Optical sensor system for 3D measurements on large gears.
AMA Conferences - SENSOR 2017, Nuremberg, 31 May - 1 Jun 2017, No. B4.3, pp. 227-232.
- C. **Dollinger**, N. Balaesque, M. Sorg, A. Fischer:
Quantitative rotorblade surface condition measurement by means of thermographic flow visualization.
WindEurope – Conference & Exhibition 2017, Amsterdam, Netherlands, 28 - 30 Nov 2017, No. PO.272. (poster)
- C. **Dollinger**, N. Balaesque, M. Sorg, A. Fischer:
Strömungsvisualisierung mittels Thermografie-Zeitreihenanalysen zur Identifikation von Strömungsablösungen an Windenergieanlagen.
25. Fachtagung Experimentelle Strömungsmechanik, Karlsruhe, 5 - 7 Sep 2017, No. 38. (8 pp.)
- C. **Dollinger**, M. Sorg, N. Balaesque, A. Fischer:
Hochauflösende thermografische Strömungsvisualisierung bei Windenergieanlagen im Betrieb.
XXXI. Messtechnisches Symposium des AHMT, Clausthal-Zellerfeld, 21 - 22 Sep 2017. *tm - Technisches Messen*, 84(S1):68-73, 2017.
- C. **Dollinger**, N. Balaesque, N. Gaudern, M. Sorg, A. Fischer:
Calculation of the power output loss based on thermographic measurement of the leading edge condition.
TORQUE 2018 The Science of Making Torque from Wind, Milano, Italy, 20 - 22 Jun 2018. *Journal of Physics: Conference Series* 1037:052011, 2018. (11 pp.)
- J. **Dong**, J. Epp, R. Lipinski, M. Sorg, H.-W. Zoch, A. Fischer:
Development of a non-destructive photothermal measuring technique for in-process analysis of nitriding treatment.
ECHT European Conference on Heat Treatment, Friedrichshafen, 12 - 13 Apr 2018, pp. 23-32.
- A. **Fischer**:
In-situ measurements of micro geometries using confocal fluorescence microscopy.
67th CIRP General Assembly, Lugano, Switzerland, 20 - 26 Aug 2017.
- L. **Langstädtler**, H. Pegel, M. Herrmann, C. Schenck, D. Stöbener, J. F. Westerkamp, A. Fischer, B. Kuhfuß:
Electrohydraulic extrusion of spherical bronze (CuSn6) micro samples.

Publications and qualification of young academics

Publications

- 8th International Conference on High Speed Forming, Columbus, Ohio/USA, 13 - 16 May 2018. (10 pp.)
- H. **Messaoudi**, F. Böhmermann, M. Mikulewitsch, A. von Freyberg, A. Fischer, O. Riemer, F. Vollertsen:
Chances and Limitations in the Application of Laser Chemical Machining for the Manufacture of Micro Forming Dies.
5th Int. Conference on New Forming Technology, Bremen, 18 Sep 2018. (accepted for publication)
 - M. **Mikulewitsch**, A. von Freyberg, A. Fischer:
Adaptive Qualitätsregelung für die laserchemische Fertigung von Mikroumformwerkzeugen.
8. Kolloquium Mikroproduktion 2017, Bremen, 27 - 28 Nov 2017, pp. 21-26.
 - M. **Mikulewitsch**, A. von Freyberg, A. Fischer:
In-situ Geometrieerfassung flüssigkeitsbedeckter Mikrostrukturen unter Verwendung konfokaler Fluoreszenzmikroskopie.
DGaO 119th Annual Meeting 2018, Aalen, 22 - 26 May 2018, No. P30. (poster)
 - J. **Osmers**, M. Sorg, A. Fischer:
Intensity based optical measurement of cornea vibration.
AMA Conferences - SENSOR 2017, Nuremberg, 30 May - 1 Jun 2017, No. D6.3, pp. 522-526.
 - M. **Sorg**, V. Renken, A. Fischer:
Untersuchung der geographischen Verteilung und zeitlichen Korrelation von Wind- und solarer Einspeisung auf Basis von Messdaten.
Windenergie – expo & congress mit STOREENERGY congress, Offenburg, 15 - 16 Nov 2017. (1 p.)
 - M. **Sorg**, J. Osmers, J. van Kempen, A. Fischer:
Bestimmung der Bohrkanallänge beim medizinischen Bohren von Knochen.
19. ITG/GMA-Fachtagung Sensoren und Messsysteme, Nuremberg, 26 - 27 Jun 2018, No. 4.3.2. (4 pp.)
 - J. **Stempin**, A. Fischer:
Regelungsstrategien für einen Thermoformprozess.
52. Regelungstechnisches Kolloquium, Boppard, 21 - 23 Feb 2018, pp. 13-14.
 - C. **Vanselow**, A. Fischer:
Einfluss von inhomogenen Brechungsindexfeldern auf PIV-Messungen.
25. Fachtagung Experimentelle Strömungsmechanik, Karlsruhe, 5 -7 Sep 2017, No. 48. (8 pp.)
 - A. **von Freyberg**, A. Fischer:
Automatic geometry segmentation of involute flank regions.
International Conference on Gears, Munich, 13 - 15 Sep 2017, pp. 1015-1024.
 - A. **von Freyberg**, A. Agour, R. B. Bergmann, A. Fischer:
Geometrische Auswertung digital holographischer Messungen im Bereich des Mikrokaltumformens.

8. Kolloquium Mikroproduktion, Bremen, 27 - 28 Nov 2017, pp. 13-20.
- A. **von Freyberg**, A. Fischer:
Automatische Geometrie-Dekomposition von 3D Punktwolken.
19. ITG/GMA-Fachtagung Sensoren und Messsysteme, Nuremberg, 26 - 27 Jun 2018, No. 3.5.4. (4 pp.)
 - J. F. **Westerkamp**, M. Sorg, A. Fischer:
High resolution speckle sensor for contactless torque measurement in wind energy systems.
AMA Conferences - SENSOR 2017, Nuremberg, 31 May - 1 Jun 2017, No. B4.4, pp. 233-237.
- Conference contributions without proceedings**
- C. **Dollinger**:
Thermografische Strömungsvisualisierung an Rotorblättern von Windenergieanlagen.
ForWind Seminar, Oldenburg, 7 Jun 2018.
 - N. **Balaresque**, C. Dollinger:
Thermographic On-Site Measurements of De-Icing Systems of Wind Turbines in Operation.
Wind Turbine Icing & Ice Prevention Forum, Berlin, 6 Oct 2017.
 - A. **Fischer**, D. Stöbener:
Speckle-based in-process measurements.
MAPEX Symposium "Process Monitoring", Bremen, 18 - 19 Jun 2018.
 - V. **Renken**., A. Fischer:
Fehlerreduktion in der additiven Fertigung durch Sensorintegration und eine adaptive Regelungsstrategie.
Workshop "Qualitätssicherung und Messtechnik in der Additiven Fertigung", Jena, 8 Mar 2018.
 - J. **Stempin**, R. Vocke, F. Jansen, A. von Freyberg, A. S. Herrmann, A. Fischer:
Development of a model-based quality control system for "zero-error" - production of flexible batch sizes in the thermoforming-process.
MAPEX Symposium "Process Monitoring", Bremen, 18 - 19 Jun 2018.
 - C. **Vanselow**, C. Dollinger, A. Fischer:
Flow field measurements under challenging in-process conditions.
MAPEX Symposium "Process Monitoring", Bremen, 18 - 19 Jun 2018.

Publications and qualification of young academics

PhD theses

Qualitätsregelungssystem eines laser-chemischen Ätzprozesses für die metallische Mikroproduktion

Dr.-Ing. Peiran Zhang

Date of thesis defense: 13 Mar 2018

Supervisor: Prof. Dr.-Ing. habil. Andreas Fischer

The thesis introduces a quality control for laser chemical machining (LCM). LCM is a laser-induced chemical etching process for the surface structuring of metallic tools for the production of microparts. The research work was part of the Collaborative Research Centre 747 Microcold Forming.

As a result, a novel LCM quality control concept was developed. The approach consists of a production-discrete quality control based on a compensation of the nonlinear control path behavior in combination with a robust, adaptive I-controller. The control loop is closed using a confocal microscope, with which the workpiece geometry is measured ex situ. With the implemented control system, the required

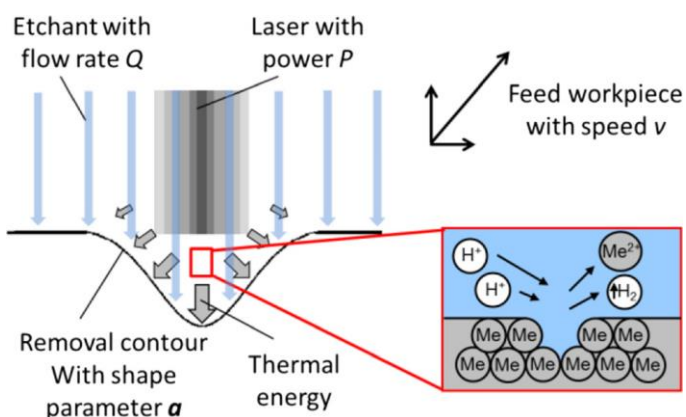

The functional principle of LCM [1]

dimensional tolerance of $\pm 5 \mu m$ was achieved after only three production steps for the production of a square die as an example. In contrast to the state of the art, an automatic instead of a manual LCM process adjustment was achieved in less than 30 % of the original time. In addition, the thermal interaction of neighboring removal paths was modeled, which allows to improve the machining quality. Finally, the presented measurement results validate the proposed LCM quality control concept.

As outlook, the control concept can be enhanced with cascaded in-process control loops when in-process measurements of the workpiece geometry become available.

Literature

- [1] P. Zhang, A. von Freyberg, A. Fischer: Closed-loop quality control system for laser chemical machining in metal micro-production. *International Journal of Advanced Manufacturing Technology* 93(9-12):3693-3703, 2017.
- [2] P. Zhang, G. Goch: A quality controlled laser-chemical process for micro metal machining. *Production Engineering* 9(5):577-583, 2015.
- [3] P. Zhang: Qualitätsregelungssystem eines laser-chemischen Ätzprozesses für die metallische Mikroproduktion. In: *Forschungsberichte des Bremer Instituts für Messtechnik, Automatisierung und Qualitätswissenschaft* (Eds. A. Fischer and G. Goch), Vol. 1, Shaker, Aachen, 2018.

Participation at events and conferences

Date of event	Event / Conference	Location	Participant(s)	
31 May - 1 Jun 2017	AMA Conferences - SENSOR 2017	Nuremberg	M. Auerswald A. Fischer J. Osmers J. Westerkamp	oral presentation session chair oral presentation oral presentation
20 Aug - 26 Aug 2017	67th CIRP General Assembly	Lugano, Switzerland	A. Fischer	technical presentation
5 Sep - 7 Sep 2017	25. Fachtagung Experimentelle Strömungsmechanik	Karlsruhe	C. Vanselow C. Dollinger	oral presentation
5 Sep - 7 Sep 2017	25. Fachtagung Experimentelle Strömungsmechanik	Karlsruhe	A. Fischer	participant
13 Sep - 15 Sep 2017	International Conference on Gears	Munich	A. von Freyberg	oral presentation
21 Sep - 22 Sep 2017	XXXI. Messtechnisches Symposium des AHMT	Clausthal- Zellerfeld	C. Dollinger	oral presentation
15 Nov - 16 Nov 2017	Windenergie – expo & congress mit STOREENERGY congress	Offenburg	M. Sorg	oral presentation
27 Nov - 28 Nov 2017	8. Kolloquium Mikroproduktion 2017	Bremen	A. von Freyberg A. Fischer M. Mikulewitsch	oral presentation scientific committee oral presentation
28 Nov - 30 Nov 2017	WindEurope – Conference & Exhibition 2017	Amsterdam, Netherlands	C. Dollinger	poster presentation
7 Feb 2018	Jugend forscht - Schüler experimentieren, Regionalwettbewerb Bremen-Mitte	Bremen	A. von Freyberg	jury member/juror
21 Feb - 23 Feb 2018	52. Regelungstechnisches Kolloquium	Boppard	J. Stempin A. Fischer	oral presentation participant
8 Mar 2018	Workshop "Qualitätssicherung und Messtechnik in der Additiven Fertigung"	Jena	V. Renken	oral presentation
22 May - 26 May 2018	DGaO 119th Annual Meeting 2018	Aalen	M. Mikulewitsch	poster presentation
18 Jun - 19 Jun 2018	MAPEX Symposium "Process Monitoring"	Bremen	A. Fischer C. Vanselow J. Stempin	oral presentation flashlight presentation
20 Jun - 22 Jun 2018	TORQUE 2018 The Science of Making Torque from Wind	Milano, Italy	C. Dollinger	oral presentation
26 Jun - 27 Jun 2018	Sensoren und Messsysteme 19. ITG/GMA-Fachtagung	Nuremberg	A. Fischer A. von Freyberg M. Sorg	participant oral presentation oral presentation

Events in Bremen

Event	Date	Organizing institution
Thermoflight project meeting	26 Jul 2017	BIMAQ
MAPEX Neighbour Visit	5 Sep 2017	MAPEX Early Career Investigators
GEOVISOL final project meeting	27 Oct 2017	BIMAQ
Young investigators Award - Deutsche WindGuard 2017	13 Dec 2017	Deutsche WindGuard GmbH
Girls Day 2018 - Workshops: "Exploring the world with electronic sense" and "photo shooting with a thermal imaging camera"	26 Apr 2018	University of Bremen / Workshops at BIMAQ
BisWind project meeting	17 May 2018	BIMAQ
Seminar "Engine Technology"	30 May 2018	BIMAQ
MoreWind project meeting - final session	14 Jun 2018	DFMRS
Students meet BIMAQ	21 Jun 2018	BIMAQ

- ThermoFlight project meeting

In the project meeting on 26 Jul 2017, BIMAQ scientists discussed the latest developments in non-destructive testing and structural health monitoring together with the project partners WindMW, Deutsche WindGuard Engineering, Otto Lutz Sachverständigenbüro and Fraunhofer IWES and scientists from the Fraunhofer WKI as well as the Technical University of Braunschweig.

The aim of the project is the development of new maintenance concepts for offshore wind turbines based on innovative measurement approaches.

- MAPEX neighbour visit:

Beyond the limits of measurability

The MAPEX Early Career Investigators regularly invite interested students and employees to join them for a short visit to one

of the MAPEX groups/institutes. On 9 Sep 2017 Dirk Stöbener, team leader of the optical metrology group of BIMAQ introduced interested visitors into the world of measurement system engineering. Main focus of the research group is continuously striving to extend the limits of optical, geometrical, gearing and speckle-metrology in several research areas. The dimensions of the investigated objects/features range from the nanometre scale up to several meters.



- GEOVISOL final project meeting

The core objective of the research project GEOVISOL was the geographical and temporal description of the renewable genera-

tion of wind and solar energy. After a term of two years (1 Sep 2015 to 31 Oct 2017) the final meeting of the GEOWISOL project took place on 27 Oct 2017.

BIMAQ as project coordinator and Deutsche WindGuard discussed their project results and their exploitation. A website was presented, in which the relative feed-in data for wind and solar energy as well as the combination for arbitrary periods are now provided in a graphical representation.

<http://geowisol.bimaq.de/>

- Young investigators Award - Deutsche WindGuard 2017

Deutsche WindGuard GmbH and BIMAQ awarded for the first time the Young Talent Award for outstanding student works.

In awarding the prize, particular emphasis was placed on progress in science, understanding of measurement systems and the relevance of research results for practical measurement tasks.

The award includes prize money of 300 € (master thesis) and 200 € (bachelor thesis).

The awards were presented to:
Wolf-Hayo **Schleevoigt** for his master thesis on the topic "Detection of defects in the ball bearing of a cup anemometer by means of structure-borne sound analysis"



and to Marc **Pillarz** for his bachelor thesis "Concept for an optical sensor for non-contact measurement of eye vibrations".



Prof. Dr.-Ing. habil. Andreas Fischer presented the certificates and the donated prize money at the annual closing ceremony of the institute.

**DEUTSCHE
WINDGUARD**

Events in Bremen

- Girls' Day

On 26 Apr 2018 the morning workshop "Exploring the world with electronic senses" dealt with electricity that we cannot see but which obeys natural laws and can make the invisible visible. Things like even heat in the home, lights that turn on automatically, doors that close automatically and can detect obstacles are a matter of course nowadays, but not possible without electricity.

In the afternoon, a very special photo workshop, "photo shooting with a thermal camera", offered the participants the opportunity to work with a camera that sees heat and depicts different temperatures in different colours. They were also allowed to bring their own things to examine.



- BiSWiND project meeting

On 17 May 2018 research and industry partners from the wind energy industry met at the BIMAQ to discuss the current status of the development of a torque sensor. The project "Component-integrated sensors for power transmission elements in wind turbines" pursues the development of a stand-alone measurement system for condition

monitoring of power transmission elements in wind turbines during operation. By means of the component-integrated sensor system for the individual power transmission elements in wind turbines, in addition to torque, speed, component temperature and the resulting vibrations, reliable information on the load is to be recorded.

- Seminar "Engine Technology"

The BIMAQ team dealt with the topic of "engine technology" in the seminar of the same name on 30 May 2018.

A tour of the engine shop at Lufthansa Technik in Hamburg taught the service range from repair work and overhauls of engines of different manufacturers, of its modules, individual parts and accessory devices and rounded off the topic of the seminar with its practical demonstrations.



- MoreWind project meeting

RWTH Aachen University and industrial partners from the measurement technology and wind energy industry met at the BIMAQ on 14 Jun 2018. The project "Model-based control of wind turbines using wind field prediction" combines the expertise of control engineering and aerodynamics in order to evaluate the potential of model-based predictive control methods in interaction with a well-founded wind field prediction within the framework of a numerical and experimental analysis and thus to prove their practical suitability for the first time.

- Students meet BIMAQ

On June 21, 2018, Prof. Fischer and scientific staff invited students of production engi-

neering, systems engineering and industrial engineering to get in touch with BIMAQ research and people.

With its research focus in measurement and control, the BIMAQ has a lot to offer to students who are interested in non-contact optical measurement systems, signal and image processing tools, the analysis of flow and production processes, model-based quality controls and the inspection and optimization of wind turbines in operation.

Topics for Bachelor and Master theses offer the opportunity to participate in current research projects.

The event including a barbecue and a Segway course was well received by the students and provided an excellent platform for a comprehensive exchange of ideas.





Impressum



Universität Bremen

BIMAQ

Bremer Institut für

Messtechnik, Automatisierung
und Qualitätswissenschaft

Prof. Dr.-Ing. habil. Andreas Fischer

Linzer Straße 13

28359 Bremen

Germany

Phone: +49/421/218-64600

Fax: +49/421/218-64670

info@bimaq.de

www.bimaq.de

June 2018